

FEATURES & SPECIFICATIONS

INTENDED USE — Typical applications include corridors, lobbies, conference rooms and private offices.

CONSTRUCTION — Galvanized steel mounting/plaster frame; galvanized steel junction box with bottom-hinged access covers and spring latches. Reflectors are retained by torsion springs.

Vertically adjustable mounting brackets with commercial bar hangers provide 3-3/4" total adjustment.

Two combination 1/2"-3/4" and four 1/2" knockouts for straight-through conduit runs. Capacity: 8 (4 in, 4 out). No. 12 AWG conductors, rated for 90°C.

Accommodates 12"-24" joist spacing.

Passive cooling thermal management for 25°C standard; high ambient (40°C) option available. Light engine and drivers are accessible from above or below ceiling.

Max ceiling thickness 1-1/2".

OPTICS — LEDs are binned to a 3-step SDCM; 80 CRI minimum. 90 CRI optional.

LED light source concealed with diffusing optical lens.

General illumination lighting with 1.0 S/MH and 55° cutoff to source and source image.

Self-flanged anodized reflectors in specular, semi-specular, or matte diffuse finishes. Also available in white and black painted reflectors.

ELECTRICAL — Multi-volt (120-277V, 50/60Hz) 0-10V dimming drivers mounted to junction box, 10% or 1% minimum dimming level available.

0-10V dimming fixture requires two (2) additional low-voltage wires to be pulled.

70% lumen maintenance at 60,000 hours.

LISTINGS — Certified to US and Canadian safety standards. Wet location standard (covered ceiling). IP55 rated. ENERGY STAR® certified product.

BUY AMERICAN — Product with the BAA option is assembled in the USA and meets the Buy America(n) government procurement requirements under FAR, DFARS and DOT. Please refer to www.acuitybrands.com/buy-american for additional information.

WARRANTY — 5-year limited warranty. This is the only warranty provided and no other statements in this specification sheet create any warranty of any kind. All other express and implied warranties are disclaimed. Complete warranty terms located at: www.acuitybrands.com/support/warranty/terms-and-conditions

Note: Actual performance may differ as a result of end-user environment and application.

All values are design or typical values, measured under laboratory conditions at 25 °C.

Specifications subject to change without notice.



A+ Capable options indicated by this color background.

Catalog Number
Notes
Type

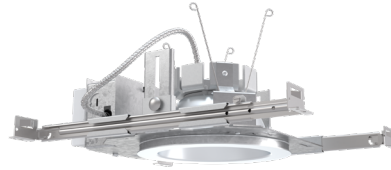

LDN6

**6" Open and WallWash LED
Non-IC
New Construction Downlight**



battery pack



ORDERING INFORMATION

Lead times will vary depending on options selected. Consult with your sales representative.

Example: LDN6 35/15 L06AR LSS MVOLT EZ10

LDN6 Series	Color temperature	Lumens ¹	Aperture/Trim Color	Finish	Voltage
LDN6 6" round	27/ 2700K	05 500 lumens	L06 Downlight	LSS Semi-specular	MVOLT Multi-volt
	30/ 3000K	07 750 lumens	LW6 Wallwash	LD Matte diffuse	120 120V
	35/ 3500K	10 1000 lumens	AR Clear	LS Specular	277 277V
	40/ 4000K	15 1500 lumens	WR ² White		347 ³ 347V
	50/ 5000K	20 2000 lumens	BR ² Black		

Driver	Options
GZ10 0-10V driver dims to 10%	SF ⁴ Single fuse
GZ1 0-10V driver dims to 1%	TRW ⁵ White painted flange
D10 Minimum dimming 10% driver for use with JOT	TRBL ⁵ Black painted flange
D1 Minimum dimming 1% driver for use with JOT	EL ⁶ Emergency battery pack with integral test switch. 10W Constant Power, Not Certified in CA Title 20 MAEDBS
EZ10 0-10V eldoLED driver with smooth and flicker-free deep dimming performance down to 10%	ELR ⁶ Emergency battery pack with remote test switch. 10W Constant Power, Not Certified in CA Title 20 MAEDBS
	ELSD ⁶ Emergency battery pack with self-diagnostics, integral test switch. 10W Constant Power, Not Certified in CA Title 20 MAEDBS
EZ1 0-10V eldoLED driver with smooth and flicker-free deep dimming performance down to 1%	ELRSD ⁶ Emergency battery pack with self-diagnostics, remote test switch. 10W Constant Power, Not Certified in CA Title 20 MAEDBS
	E10WCP ⁶ Emergency battery pack, 10W Constant Power with integral test switch. Certified in CA Title 20 MAEDB
EDAB eldoLED DALI SOLDRIIVE dim to dark	E10WCPR ⁶ Emergency battery pack, 10W Constant Power with remote test switch. Certified in CA Title 20 MAEDB
	NPP16D ⁷ nLight [®] network power/relay pack with 0-10V dimming for non-eldoLED drivers (GZ10, GZ1).
	NPP16DER ⁷ nLight [®] network power/relay pack with 0-10V dimming for non-eldoLED drivers (GZ10, GZ1). ER controls fixtures on emergency circuit.
	N80 ⁸ nLight™ Lumen Compensation
	JOT ¹³ Wireless room control with "Just One Touch" pairing
	NPS80EZ ⁷ nLight [®] dimming pack controls 0-10V eldoLED drivers (EZ10, EZ1).
	NPS80EZER ⁷ nLight [®] dimming pack controls 0-10V eldoLED drivers (EZ10, EZ1). ER controls fixtures on emergency circuit.
	HAO ¹¹ High ambient option
	CP ¹² Chicago Plenum
	RRL___ RELOC [®] -ready luminaire connectors enable a simple and consistent factory installed option across all ABL luminaire brands. Available only in RRLA, RRLB, RRLAE, and RRLC12S. Refer to RRL spec sheet on www.acuitybrands.com for the RELOC product specifications.
	NLTAIR2 ^{9, 10, 14} nLight [®] Air enabled
	NLTAIRER2 ^{9, 10} nLight [®] AIR Dimming Pack Wireless Controls. Controls fixtures on emergency circuit, not available with battery pack options
	NLTAIREM2 ^{9, 10} nLight [®] AIR Dimming Pack Wireless Controls. UL924 Emergency Operation, via power interrupt detection. Available with battery pack options.
	BAA Buy America(n) Act Compliant
	90CRI High CRI (90+)

Accessories: Order as separate catalog number.	
PS1055CP	FMC Power Sentry battery pack, T20 compliant, field installable, 10w constant power
EAC ISSM 375	Compact interruptible emergency AC power system
EAC ISSM 125	Compact interruptible emergency AC power system
GRA68 JZ	Oversized trim ring with 8" outside diameter
SCA6	Sloped Ceiling Adapter. Degree of slope must be specified (5D, 10D, 15D, 20D, 25D, 30D). Ex: SCA6 10D

Notes

- Overall height varies based on lumen package; refer to dimensional chart on page 3.
- Not available with finishes.
- Not available with emergency options.
- Must specify voltage 120V or 277V.
- Available with clear (AR) reflector only.
- 12.5" of plenum depth or top access required for battery pack maintenance.
- Specify voltage. ER for use with generator supply EM power. Will require an emergency hot feed and normal hot feed.
- Fixture begins at 80% light level. Must be specified with NPS80EZ or NPS80EZER. Only available with EZ10 and EZ1 drivers.
- Not available with CP, NPS80EZ, NPS80EZER, NPP16D, NPP16DER or N80 options.
- NLTAIR2, NLTAIRER2 and NLTAIREM2 not recommended for metal ceiling installations.
- Fixture height is 6.5" for all lumen packages with HAO.
- Must specify voltage for 3000lm and above. 5000lm with marked spacing 24 L x 24 W x 14 H. Not available with emergency battery pack option.
- Must specify D10 or D1 driver. Not available with nLight options. Not available with CP. Not recommended for metal ceiling installation. Not for use with emergency backup power systems other than battery packs.
- When combined with EZ1 or EZ10 drivers, can be used as a normal power sensing device for nLight AIR devices and luminaires with EM options.

LDN6

PHOTOMETRY

Distribution Curve Distribution Data Output Data Coefficient of Utilization Illuminance Data at 30" Above Floor for a Single Luminaire

LDN6 35/10 L06AR, input watts: 10.44, delivered lumens: 987.10, LM/W = 94.54, spacing criterion at 0= 1.02, test no. ISF 30716P262.

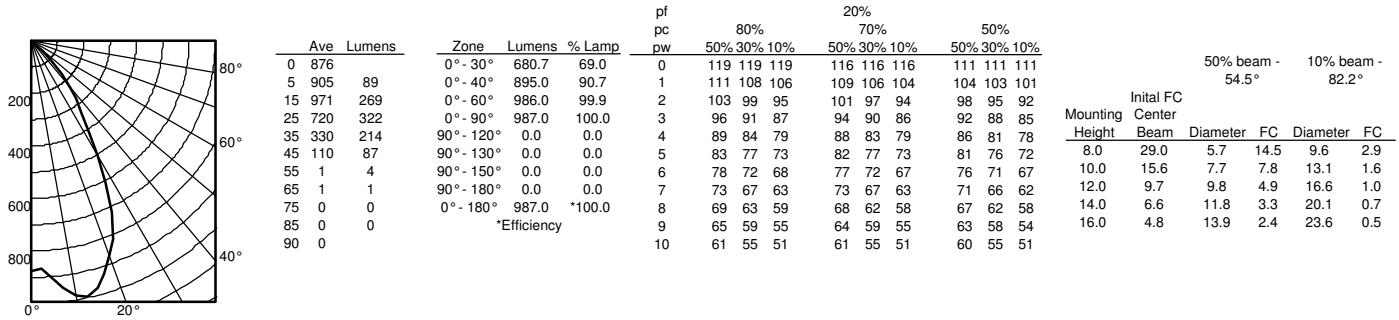

LDN6 35/15 L06AR, input watts: 17.52, delivered lumens: 1572.9, LM/W = 89.77, spacing criterion at 0= 1.02, test no. ISF 30716P265.

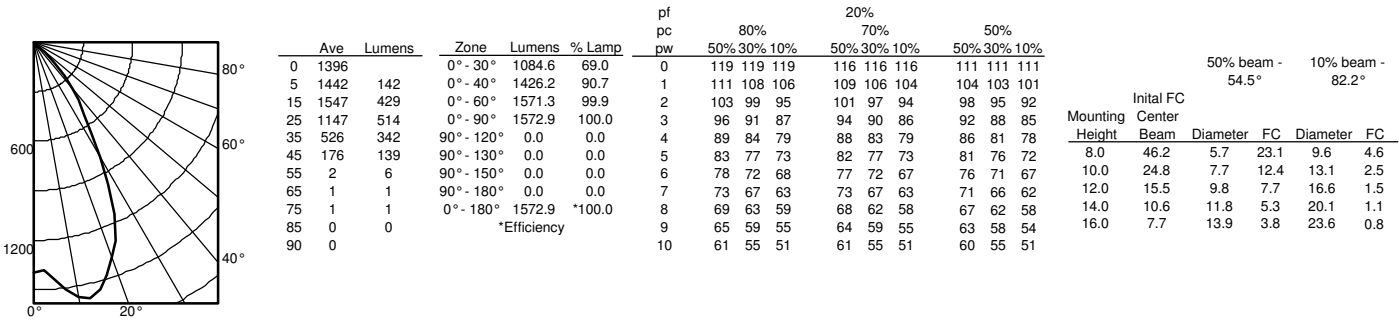

LDN6 35/30 L06AR, input watts: 34.75, delivered lumens: 3138.5, LM/W = 90.31, spacing criterion at 0= 1.02, test no. ISF 30716P274.

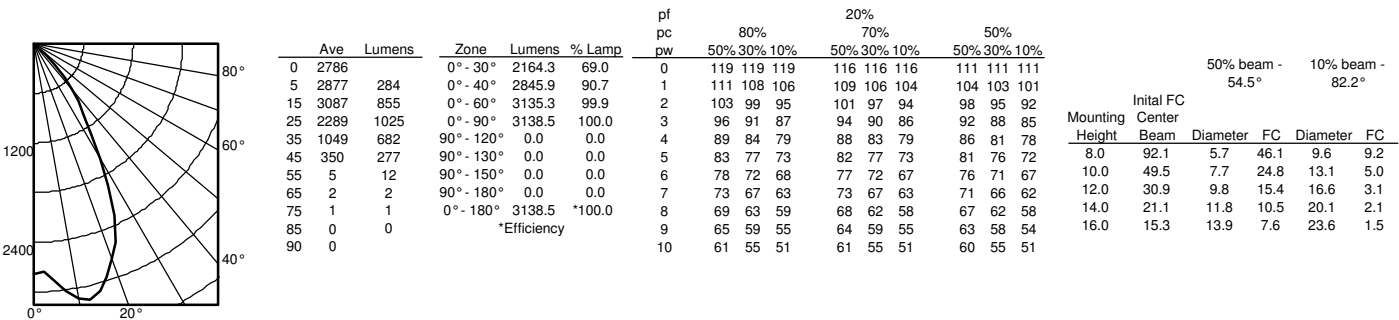

LDN6

* All dimensions are inches (centimeters) unless otherwise noted.

LDN6 500 - 1500 LUMENS

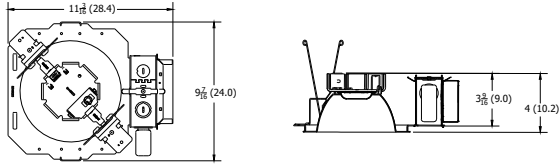

Aperture: 6-1/4 (15.9)
Ceiling Opening: 7-1/8 (18.1)
Overlap Trim: 7-1/2 (19.1)

LDN6 2000 - 3000 LUMENS

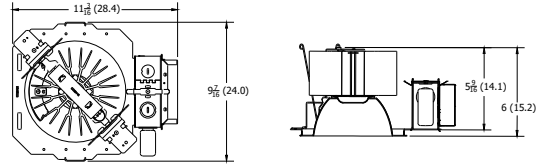

Aperture: 6-1/4 (15.9)
Ceiling Opening: 7-1/8 (18.1)
Overlap Trim: 7-1/2 (19.1)

LDN6 4000 - 5000 LUMENS

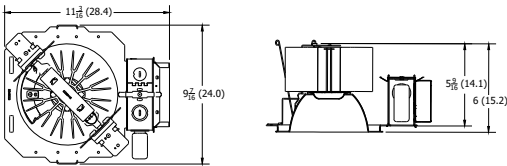

Marked Spacing: 24 x 24 x 10
Aperture: 6-1/4 (15.9)
Ceiling Opening: 7-1/8 (18.1)
Overlap Trim: 7-1/2 (19.1)

LDN6 CP

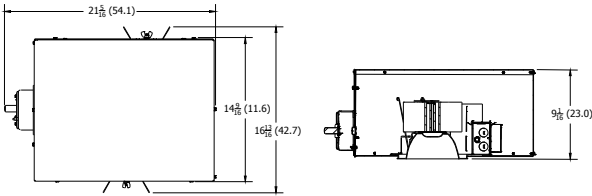

Aperture: 6-1/4 (15.9)
Ceiling Opening: 7-1/8 (18.1)
Overlap Trim: 7-1/2 (19.1)

LDN6 EL

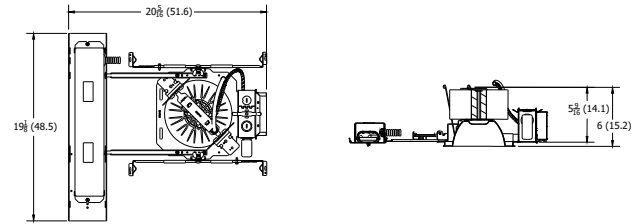

Marked Spacing above 3000 Lumens: 24 x 24 x 10
Aperture: 6-1/4 (15.9)
Ceiling Opening: 7-1/8 (18.1)
Overlap Trim: 7-1/2 (19.1)

LDN6			
Nominal Lumens	Lumens	Wattage	Lm/W
500	527.9	5.8	90.5
750	758.1	8.9	85.1
1000	950.1	10.4	91.0
1500	1514	17.5	86.4
2000	2006	22.5	89.1
2500	2504	28.3	88.6
3000	3021	34.8	86.9
4000	4008	44.3	90.6
5000	4975	57.7	86.3

HOW TO ESTIMATE DELIVERED LUMENS IN EMERGENCY MODE

Use the formula below to estimate the delivered lumens in emergency mode

$$\text{Delivered Lumens} = 1.25 \times P \times \text{LPW}$$

P = Output power of emergency driver. P = 10W for PS1055CP

LPW = Lumen per watt rating of the luminaire. This information is available on the ABL luminaire spec sheet.

The LPW rating is also available at Designlight Consortium.

LUMEN OUTPUT MULTIPLIERS - FINISH			
	Clear (AR)	White (WR)	Black (BR)
Specular (LS)	1.0	N/A	N/A
Semi-specular (LSS)	0.950	N/A	N/A
Matte diffuse (LD)	0.85	N/A	N/A
Painted	N/A	0.87	0.73

LUMEN OUTPUT MULTIPLIERS - CCT					
	2700K	3000K	3500K	4000K	5000K
80CRI	0.950	0.966	1.000	1.025	1.101

Notes

- Tested in accordance with IESNA LM-79-08.
- Tested to current IES and NEMA standards under stabilized laboratory conditions.
- CRI: 80 typical.

ADDITIONAL DATA



The Sensor Switch JOT enabled solution offers a wireless, app-free approach to single room lighting control. JOT enabled products use Bluetooth® Low Energy (BLE) technology to enable wireless dimming and switching.

Diagram

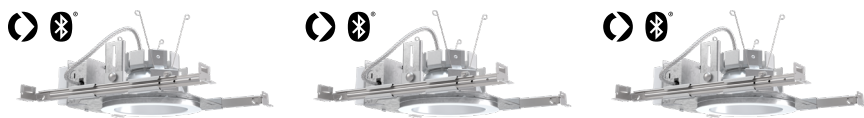

LDN6 Series



Sensor Switch
WSXA JOT

1. **Power:** Install JOT enabled fixtures and controls as instructed.
2. **Pair:** Insert the pairing tool into the pinhole on the wall switch; press and hold any button for 6 seconds.
3. **Play:** Once paired, each fixture will individually dim down to 10% brightness. All products will be fully functional.

COMPATIBLE 0-10V WALL-MOUNT DIMMERS		
MANUFACTURER	PART NO.	POWER BOOSTER AVAILABLE
Lutron®	Diva® DDTV	
	Diva® DVSCTV	
	Nova T® NTFTV	
	Nova® NFTV	
Leviton®	AWSMT-7DW	CN100
	AWSMG-7DW	PE300
	AMRMG-7DW	
	Leviton Centura Fluorescent Control System	
	IllumaTech® IP7 Series	
Synergy®	ISD BC	RDMFC
	SLD LPCS	
	Digital Equinox (DEQ BC)	
Douglas Lighting Controls	WPC-5721	
Entertainment Technology	Tap Glide TG600FAM120 (120V)	
	Tap Glide Heatsink TGH1500FAM120 (120V)	
	Oasis OA2000FAMU	
Honeywell	EL7315A1019	EL7305A1010 (optional)
	EL7315A1009	
HUNT Dimming	Preset slide: PS-010-IV and PS-010-WH	
	Preset slide: PS-010-3W-IV and PS-010-3W-WH	
	Preset slide, controls FD-010: PS-IFC-010-IV and PS-IFC-010-WH-120/277V	
	Preset slide, controls FD-010: PS-IFC-010-3W-IV and PS-IFC-010-3W-WH-120/277V	
	Remote mounted unit: FD-010	
Lehigh Electronic Products	Solitaire	PBX
PDM Electrical Products	WPC-5721	
Starfield Controls	TR61 with DALI interface port	RT03 DALI.net Router
WattStopper®	LS-4 used with LCD-101 and LCD-103	

A+ Capable Luminaire

This item is an A+ capable luminaire, which has been designed and tested to provide consistent color appearance and out-of-the-box control compatibility with simple commissioning.

- All configurations of this luminaire meet the Acuity Brands' specification for chromatic consistency
- This luminaire is part of an A+ Certified solution for nLight® control networks when ordered with drivers marked by a shaded background*
- This luminaire is part of an A+ Certified solution for nLight control networks, providing advanced control functionality at the luminaire level, when selection includes driver and control options marked by a shaded background*

To learn more about A+, visit www.acuitybrands.com/aplus.

*See ordering tree for details

LDN6

EXAMPLE

Group Fixture Control*

*Application diagram applies for fixtures with eldoLED drivers only.

nPS 80 EZ Dimming/Control Pack (qty: 2 required)

nPODM 2P DX Dual On/Off/Dim Push-Button WallPod

nCM ADCX Daylight Sensor with Automatic Dimming Control

nCM PDT 9 Dual Technology Occupancy Sensor

Description: This design provides a dual on/off/dim wall station that enables manual control of the fixtures in Row A and Row B separately. Additionally, a daylight harvesting sensor is provided so the lights in Row B can be configured to dim automatically when daylight is available. An occupancy sensor turns off all lights when the space is vacant.

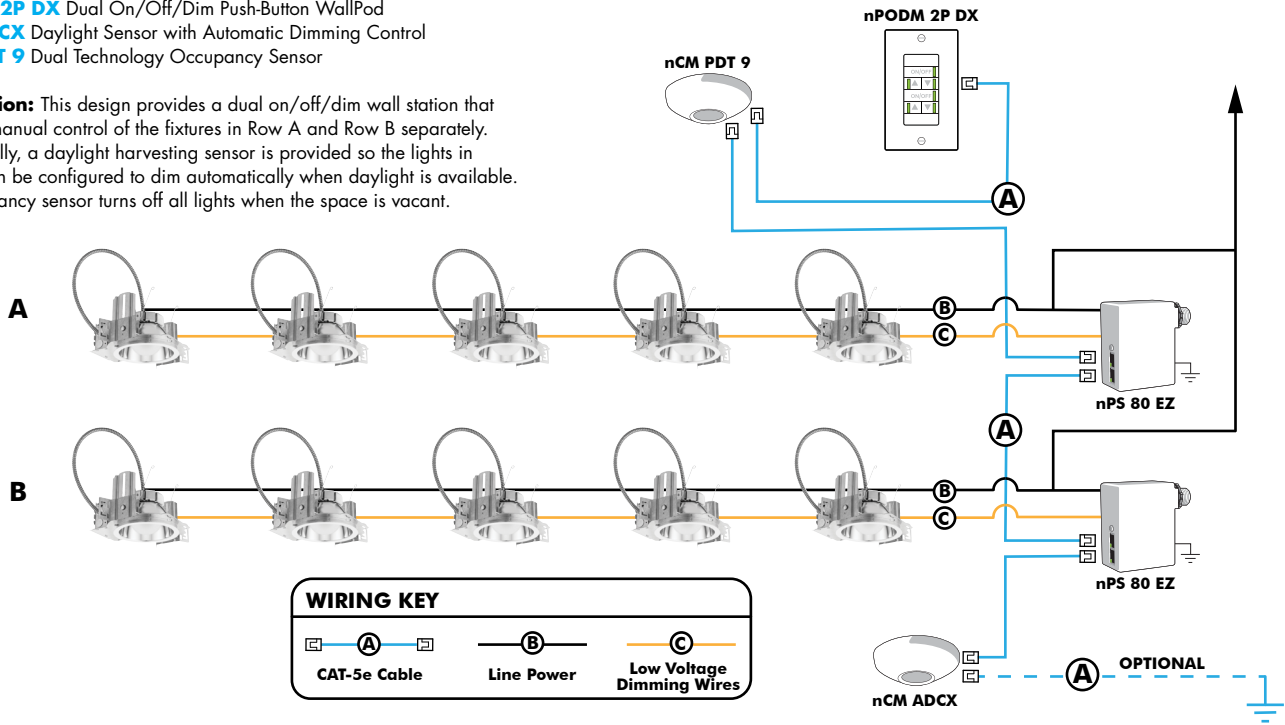

Choose Wall Controls

nLight offers multiple styles of wall controls - each with varying features and user experience.



Push-Button Wallpod

Traditional tactile buttons and LED user feedback



Graphic Wallpod

Full color touch screen provides a sophisticated look and feel

nLight® Wired Controls Accessories:

Order as separate catalog number. Visit www.acuitybrands.com/products/controls/nlight for complete listing of nLight controls.			
WallPod Stations	Model number	Occupancy sensors	Model Number
On/Off	nPODM (Color)	Small motion 360°, ceiling (PIR/dual Tech)	nCM 9 / nCM PDT 9
On/Off & Raise/Lower	nPOD DX (Color)	Large motion 360°, ceiling (PIR/dual tech)	nCM 10 / nCM PDT 10
Graphic Touchscreen	nPOD GFX (Color)	Wide View (PIR/dual tech)	nWV 16 / nWV PDT 16
Photocell controls	Model Number	Wall Switch w/ Raise/Lower (PIR/dual tech)	nWSX LV DX / nWSX PDT LV DX
Dimming	nCM ADCX	Cat-5 cables (plenum rated)	Model Number
		10', CAT5 10FT	CATS 10FT J1
		15', CAT5 15FT	CATS 15FT J1

nLight® AIR Control Accessories:

Order as separate catalog number. Visit www.acuitybrands.com/products/controls/nlightair.

Wall switches	Model number
On/Off single pole	rPODB [color]
On/Off two pole	rPODB 2P [color]
On/Off & raise/lower single pole	rPODB DX [color]
On/Off & raise/lower two pole	rPODB 2P DX [color]
On/Off & raise/lower single pole	rPODBZ DX WH ¹

Notes

- 1 Can only be ordered with the RES7Z zone control sensor version.

UL924 Sequence of Operation

The below information applies to all nLight AIR devices with an EM option.

- EM devices will remain at their high-end trim and ignore wireless lighting control commands, unless a normal-power-sensed (NPS) broadcast is received at least every 8 seconds.
- Using the CLAIRITY+ mobile app, EM devices must be associated with a group that includes a normal power sensing device to receive NPS broadcasts.
- Only non-emergency rPP20, rLSXR, rSBOR, rSDGR, and nLight AIR luminaires with version 3.4 or later firmware can provide normal power sensing for EM devices. See specification sheets for control devices and luminaires for more information on options that support normal power sensing.

nLight AIR

nLight AIR is the ideal solution for retrofit or new construction spaces where adding communication is cost prohibitive. The integrated nLight AIR rPP20 Power Pack is part of each Lithonia LDN Luminaire. These individually addressable controls offer the ultimate in flexibility during initial setup and for space repurposing.

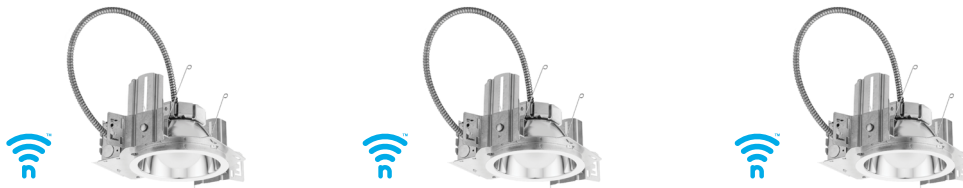

Simple as 1,2,3

1. Install the nLight® AIR fixtures with embedded smart sensor
2. Install the wireless battery-powered wall switch
3. With CLAIRITY app, pair the fixtures with the wall switch and if desired, customize the sensor settings for the desired outcome





WST LED

Architectural Wall Sconce



Buy American

Catalog Number

Notes

Type

Hit the Tab key or mouse over the page to see all interactive elements.

Specifications

Luminaire

- Height:** 8-1/2"
(21.59 cm)
- Width:** 17"
(43.18 cm)
- Depth:** 10-3/16"
(25.9 cm)
- Weight:** 20 lbs
(9.1 kg)

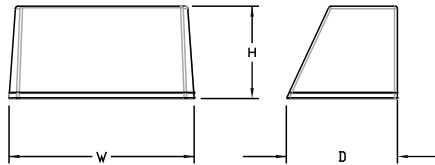

A+ Capable options indicated by this color background.

Introduction

The WST LED is designed with the specifier in mind. The traditional, trapezoidal shape offers a soft, non-pixelated light source for end-user visual comfort. For emergency egress lighting, the WST LED offers six battery options, including remote. For additional code compliance and energy savings, there is also a Bi-level motion sensor option. With so many standard and optional features, three lumen packages, and high LPW, the WST LED is your "go to" luminaire for most any application.

Ordering Information

EXAMPLE: WST LED P1 40K VF MVOLT DDBTXD

WST LED	Performance Package	Color temperature	Distribution	Voltage	Mounting
WST LED	P1 1,500 Lumen package P2 3,000 Lumen package P3 6,000 Lumen package	27K 2700 K 30K 3000 K 40K 4000 K 50K 5000 K	VF Visual comfort forward throw VW Visual comfort wide	MVOLT ¹ 277 ² 120 ² 347 ² 208 ² 480 ² 240 ²	Shipped included (blank) Surface mounting bracket PBBW Premium surface-mounted back box ^{3,4} Shipped separately BBW Surface-mounted back box ³

Options	Finish (required)	
NLTAIR2 PIR nLIGHT AIR Wireless enabled motion/ambient sensor for 8'-15' mounting heights ^{5,6,7}	E7WC Emergency battery backup, CA Title 20 Noncompliant (cold, 7W) ^{7,12}	DDBXD Dark bronze
NLTAIR2 PIRH nLIGHT AIR Wireless enabled motion/ambient sensor for 15'-30' mounting heights ^{5,6,7}	E7WHR Remote emergency battery backup, CA Title 20 Noncompliant (remote 7W) ^{7,13}	DBLXD Black
PE Photoelectric cell, button type ⁸	E20WH Emergency battery pack 18W constant power, Certified in CA Title 20 MAEDBS ⁷	DNAXD Natural aluminum
PER NEMA twist-lock receptacle only (controls ordered separate) ⁹	E20WC Emergency battery pack -20°C 18W constant power, Certified in CA Title 20 MAEDBS ^{7,12}	DWHXD White
PERS Five-wire receptacle only (controls ordered separate) ⁹	E20WHR Remote emergency battery backup, CA Title 20 Noncompliant (remote 20W) ^{7,12,14}	DSSXD Sandstone
PER7 Seven-wire receptacle only (controls ordered separate) ⁹	LCE Left side conduit entry ¹⁵	DDBTXD Textured dark bronze
PIR Motion/Ambient Light Sensor, 8-15' mounting height ^{5,6}	RCE Right side conduit entry ¹⁵	DBLBSD Textured black
PIR1FC3V Motion/ambient sensor, 8-15' mounting height, ambient sensor enabled at 1fc ^{5,6}	BAA Buy America(n) Act Compliant	DNATXD Textured natural aluminum
PIRH 180° motion/ambient light sensor, 15-30' mounting height ^{5,6}	Shipped separately	DWHGXD Textured white
PIRH1FC3V Motion/ambient sensor, 15-30' mounting height, ambient sensor enabled at 1fc ^{5,6}	RBPW Retrofit back plate ³	DSSTXD Textured sandstone
SF Single fuse (120, 277, 347V) ²	VG Vandal guard ¹⁵	
DF Double fuse (208, 240, 480V) ²	WG Wire guard ¹⁵	
DS Dual switching ¹⁰		
DMG 0-10V dimming extend out back of housing for external control (control ordered separate) ¹¹		
E7WH Emergency battery backup, Non CEC compliant (7W) ⁷		

See Accessories and Notes on next page.



COMMERCIAL OUTDOOR

One Lithonia Way • Conyers, Georgia 30012 • Phone: 800-705-SERV (7378) • www.lithonia.com
 © 2011-2022 Acuity Brands Lighting, Inc. All rights reserved.

WST-LED
 Rev. 08/02/22

Accessories

Ordered and shipped separately.

WSTVCPBBW DDBXD U	Premium Surface - mounted back box
WSBBW DDBTXD U	Surface - mounted back box
RBPW DDBXD U	Retrofit back plate
DLL127F 1.5 JU	Photocell - SSL twist-lock (120-277V) ¹⁷
DLL347F 1.5 CUL JU	Photocell - SSL twist-lock (347V) ¹⁷
DLL480F 1.5 CUL JU	Photocell - SSL twist-lock (480V) ¹⁷

NOTES

- MVOLT driver operates on any line voltage from 120-277V (50/60 Hz).
- Single fuse (SF) requires 120V, 277V or 347V. Double fuse (DF) requires 208V, 240V or 480V.
- Also available as a separate accessory; see accessories information.
- Top conduit entry standard.
- Not available with VG or WG. See PER Table.
- Reference Motion Sensor table.
- Not available with 347/480V.
- Need to specify 120, 208, 240 or 277 voltage.
- Photocell ordered and shipped as a separate line item from Acuity Brands Controls. Shorting Cap included.
- Not available with Emergency options, PE or PER options.
- DMG option not available with standalone or networked sensors/controls.
- Battery pack rated for -20° to 40°C.
- Comes with PBBW.
- Warranty period is 3-years.
- Not available with BBW.
- Must order with fixture; not an accessory.
- Requires luminaire to be specified with PER, PER5 or PER7 option. See PER Table.

Optional Back Box (PBBW)

Height:	8.49" (21.56 cm)
Width:	17.01" (43.21 cm)
Depth:	1.70" (4.32 cm)

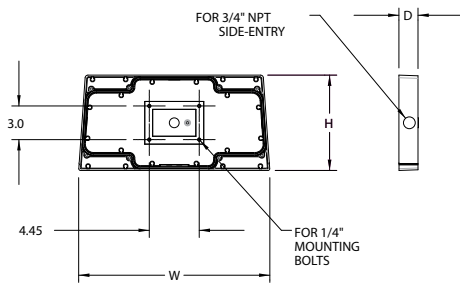

Optional Back Box (BBW)

Height:	4" (10.2 cm)
Width:	5-1/2" (14.0 cm)
Depth:	1-1/2" (3.8 cm)

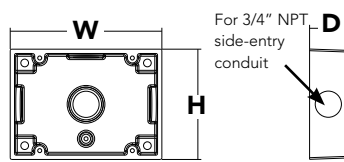

Emergency Battery Operation

The emergency battery backup is integral to the luminaire — no external housing required! This design provides reliable emergency operation while maintaining the aesthetics of the product.

All emergency backup configurations include an independent secondary driver with an integral relay to immediately detect AC power loss, meeting interpretations of [NFPA 70/NEC 2008 - 700.16](#)

The emergency battery will power the luminaire for a minimum duration of 90 minutes (maximum duration of three hours) from the time supply power is lost, per [International Building Code Section 1006](#) and [NFPA 101 Life Safety Code Section 7.9](#), provided luminaires are mounted at an appropriate height and illuminate an open space with no major obstructions.

The examples below show illuminance of 1 fc average and 0.1 fc minimum of the P1 power package and VF distribution product in emergency mode.

10' x 10' Gridlines
8' and 12' Mounting Height

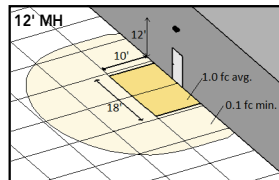
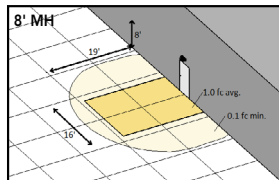

WST LED P1 27K VF MVOLT E7WH

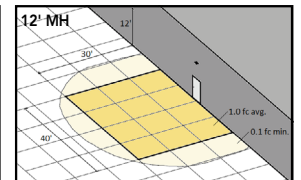
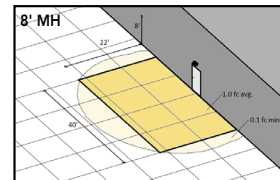

WST LED P2 40K VF MVOLT E20WH

Performance Data

Lumen Ambient Temperature (LAT) Multipliers

Use these factors to determine relative lumen output for average ambient temperatures from 0-40°C (32-104°F).

Ambient		Lumen Multiplier
0°C	32°F	1.03
10°C	50°F	1.02
20°C	68°F	1.01
25°C	77°F	1.00
30°C	86°F	0.99
40°C	104°F	0.98

Projected LED Lumen Maintenance

Values calculated according to IESNA TM-21-11 methodology and valid up to 40°C.

Operating Hours	0	25,000	50,000	100,000
Lumen Maintenance Factor	1.0	>0.95	>0.92	>0.87

Electrical Load

Performance package	System Watts	Current (A)					
		120	208	240	277	347	480
P1	11	0.1	0.06	0.05	0.04	---	---
	14	---	---	---	---	0.04	0.03
P1 DS	14	0.12	0.07	0.06	0.06	---	---
P2	25	0.21	0.13	0.11	0.1	---	---
	30	---	---	---	---	0.09	0.06
P2 DS	25	0.21	0.13	0.11	0.1	---	---
P3	50	0.42	0.24	0.21	0.19	---	---
	56	---	---	---	---	0.16	0.12
P3 DS	52	0.43	0.26	0.23	0.21	---	---

Motion Sensor Default Settings

Option	Dimmed State	High Level (when triggered)	Photocell Operation	Ramp-up Time	Dwell Time	Ramp-down Time
*PIR or PIRH	3V (37%) Output	10V (100%) Output	Enabled @ 5FC	3 sec	5 min	5 min
PIR1FC3V or PIRH1FC3V	3V (37%) Output	10V (100%) Output	Enabled @ 1FC	3 sec	5 min	5 min

*for use with site wide Dusk to Dawn control

PER Table

Control	PER (3 wire)	PER5 (5 wire)			PER7 (7 wire)		
		Wire 4/Wire5	Wire 4/Wire5	Wire 4/Wire5	Wire 4/Wire5	Wire 6/Wire7	
Photocontrol Only (On/Off)	✓	⚠	Wired to dimming leads on driver	⚠	Wired to dimming leads on driver	Wires Capped inside fixture	
ROAM	⊘	✓	Wired to dimming leads on driver	⚠	Wired to dimming leads on driver	Wires Capped inside fixture	
ROAM with Motion	⊘	⚠	Wired to dimming leads on driver	⚠	Wired to dimming leads on driver	Wires Capped inside fixture	
Futureproof*	⊘	⚠	Wired to dimming leads on driver	✓	Wired to dimming leads on driver	Wires Capped inside fixture	
Futureproof* with Motion	⊘	⚠	Wired to dimming leads on driver	✓	Wired to dimming leads on driver	Wires Capped inside fixture	

✓ Recommended

⊘ Will not work

⚠ Alternate

*Futureproof means: Ability to change controls in the future.

Lumen Output

Lumen values are from photometric tests performed in accordance with IESNA LM-79-08. Data is considered to be representative of the configurations shown, within the tolerances allowed by Lighting Facts.

Performance Package	System Watts (MVOLT ¹)	Dist. Type	27K (2700K, 70 CRI)					30K (3000K, 70 CRI)					40K (4000K, 70 CRI)					50K (5000K, 70 CRI)				
			Lumens	B	U	G	LPW	Lumens	B	U	G	LPW	Lumens	B	U	G	LPW	Lumens	B	U	G	LPW
P1	12W	VF	1,494	0	0	0	125	1,529	0	0	0	127	1,639	0	0	0	137	1,639	0	0	0	137
		VW	1,513	0	0	0	126	1,548	0	0	0	129	1,659	0	0	0	138	1,660	0	0	0	138
P2	25W	VF	3,163	1	0	1	127	3,237	1	0	1	129	3,469	1	0	1	139	3,468	1	0	1	139
		VW	3,201	1	0	0	128	3,276	1	0	0	131	3,512	1	0	0	140	3,512	1	0	0	140
P3	50W	VF	6,025	1	0	1	121	6,165	1	0	1	123	6,609	1	0	1	132	6,607	1	0	1	132
		VW	6,098	1	0	1	122	6,240	1	0	1	125	6,689	1	0	1	134	6,691	1	0	1	134



Isofootcandle plots for the WST LED P3 40K VF and VW. Distances are in units of mounting height (10').

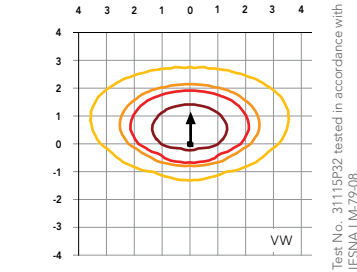
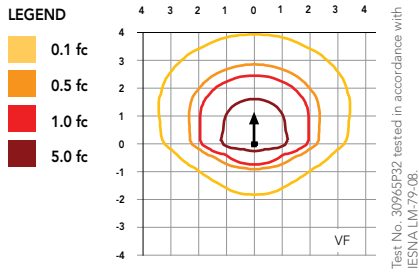

Distribution overlay comparison to 175W metal halide.

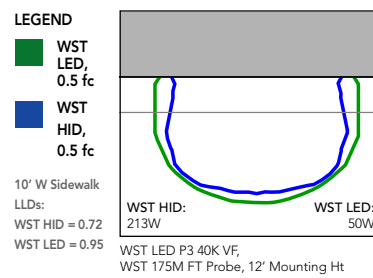

FEATURES & SPECIFICATIONS

INTENDED USE

The classic architectural shape of the WST LED was designed for applications such as hospitals, schools, malls, restaurants, and commercial buildings. The long life LEDs and driver make this luminaire nearly maintenance-free.

CONSTRUCTION

The single-piece die-cast aluminum housing integrates secondary heat sinks to optimize thermal transfer from the internal light engine heat sinks and promote long life. The driver is mounted in direct contact with the casting for a low operating temperature and long life. The die-cast door frame is fully gasketed with a one-piece solid silicone gasket to keep out moisture and dust, providing an IP65 rating for the luminaire.

FINISH

Exterior parts are protected by a zinc-infused Super Durable TGIC thermoset powder coat finish that provides superior resistance to corrosion and weathering. A tightly controlled multi-stage process ensures a minimum 3 mils thickness for a finish that can withstand extreme climate changes without cracking or peeling. Standard Super Durable colors include dark bronze, black, natural aluminum, sandstone and white. Available in textured and non-textured finishes.

OPTICS

Well crafted reflector optics allow the light engine to be recessed within the luminaire, providing visual comfort, superior distribution, uniformity, and spacing in wall-mount applications. The WST LED has zero uplight and qualifies as a Nighttime Friendly™ product, meaning it is consistent with the LEED® and Green Globes™ criteria for eliminating wasteful uplight.

ELECTRICAL

Light engine(s) consist of 98 high-efficacy LEDs mounted to a metal core circuit board and integral aluminum heat sinks to maximize heat dissipation and promote long life (100,000 hrs at 40°C, L87). Class 2 electronic driver has a power factor >90%, THD <20%. Easily-serviceable surge protection device meets a minimum Category B (per ANSI/IEEE C62.41.2).

INSTALLATION

A universal mounting plate with integral mounting support arms allows the fixture to hinge down for easy access while making wiring connections.

LISTINGS

CSA certified to U.S. and Canadian standards. Luminaire is IP65 rated. PIR and back box options are rated for wet location. Rated for -30°C to 40°C ambient.

BUY AMERICAN

Product with the BAA option is assembled in the USA and meets the Buy America(n) government procurement requirements under FAR, DFARS and DOT. Please refer to www.acuitybrands.com/buy-american for additional information.

WARRANTY

5-year limited warranty. This is the only warranty provided and no other statements in this specification sheet create any warranty of any kind. All other express and implied warranties are disclaimed. Complete warranty terms located at: www.acuitybrands.com/support/warranty/terms-and-conditions

Note: Actual performance may differ as a result of end-user environment and application.

All values are design or typical values, measured under laboratory conditions at 25 °C. Specifications subject to change without notice.