

Section Details: Operating

Scale: 3" = 1' 0"

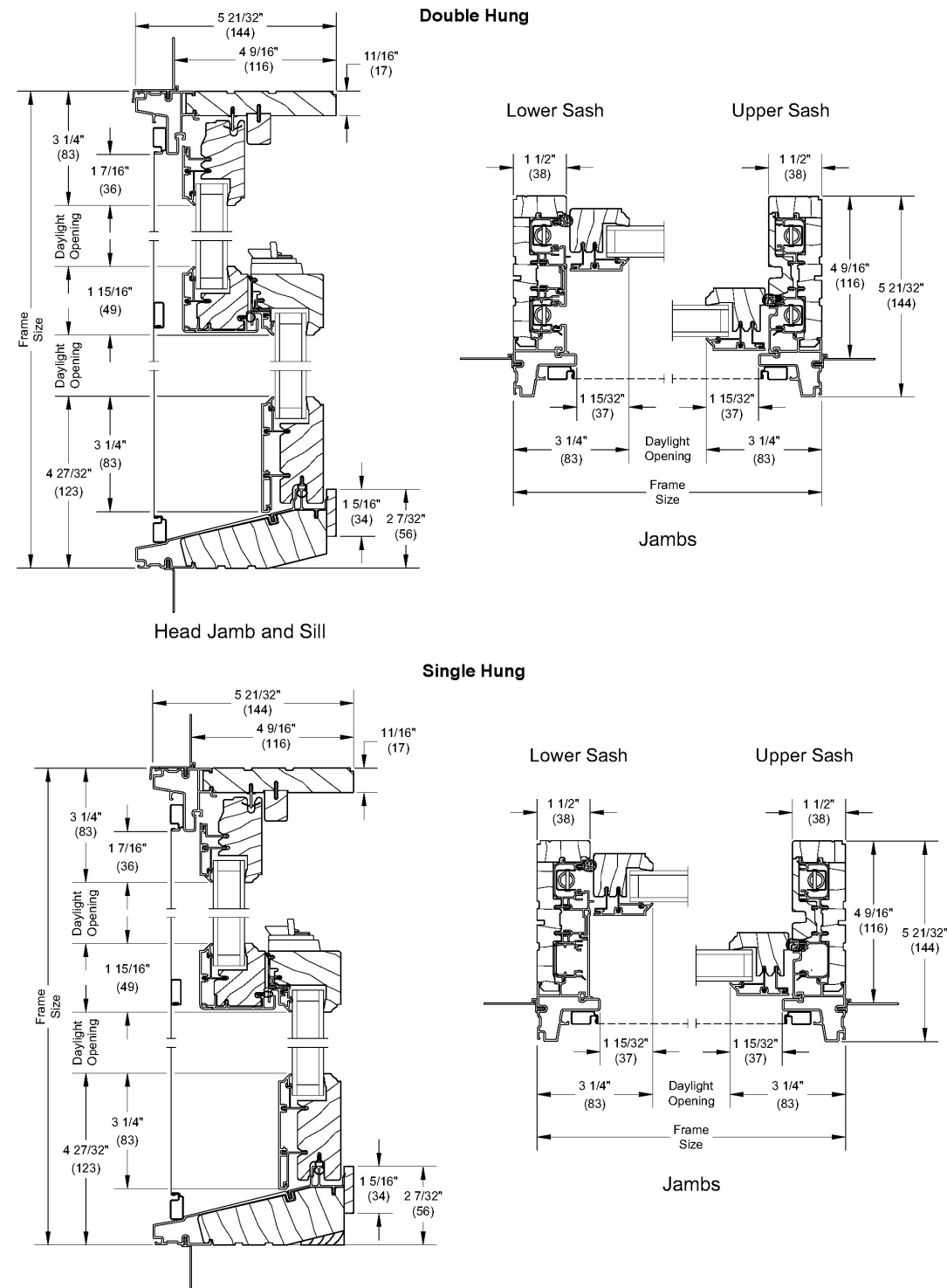

MARVIN SIGNATURE® ULTIMATE

Clad Color Options

Our low maintenance clad-wood products feature an extruded aluminum exterior paint. Because our finish meets the toughest American Architectural Manufacturer richest and boldest hues to resist fading and chalking even in harsh sun or extreme muted, earthy tones to bold, rich colors and three pearlescent finishes. Custom co

The American Architectural Manufacturers Association (AAMA) awards certification simulate the harsh conditions that a finish will encounter throughout the life of the AAMA verification provides independent verification that our finishes are best-in-c



Selected: Sierra White



Section Details: Operating

Scale: 3" = 1' 0"

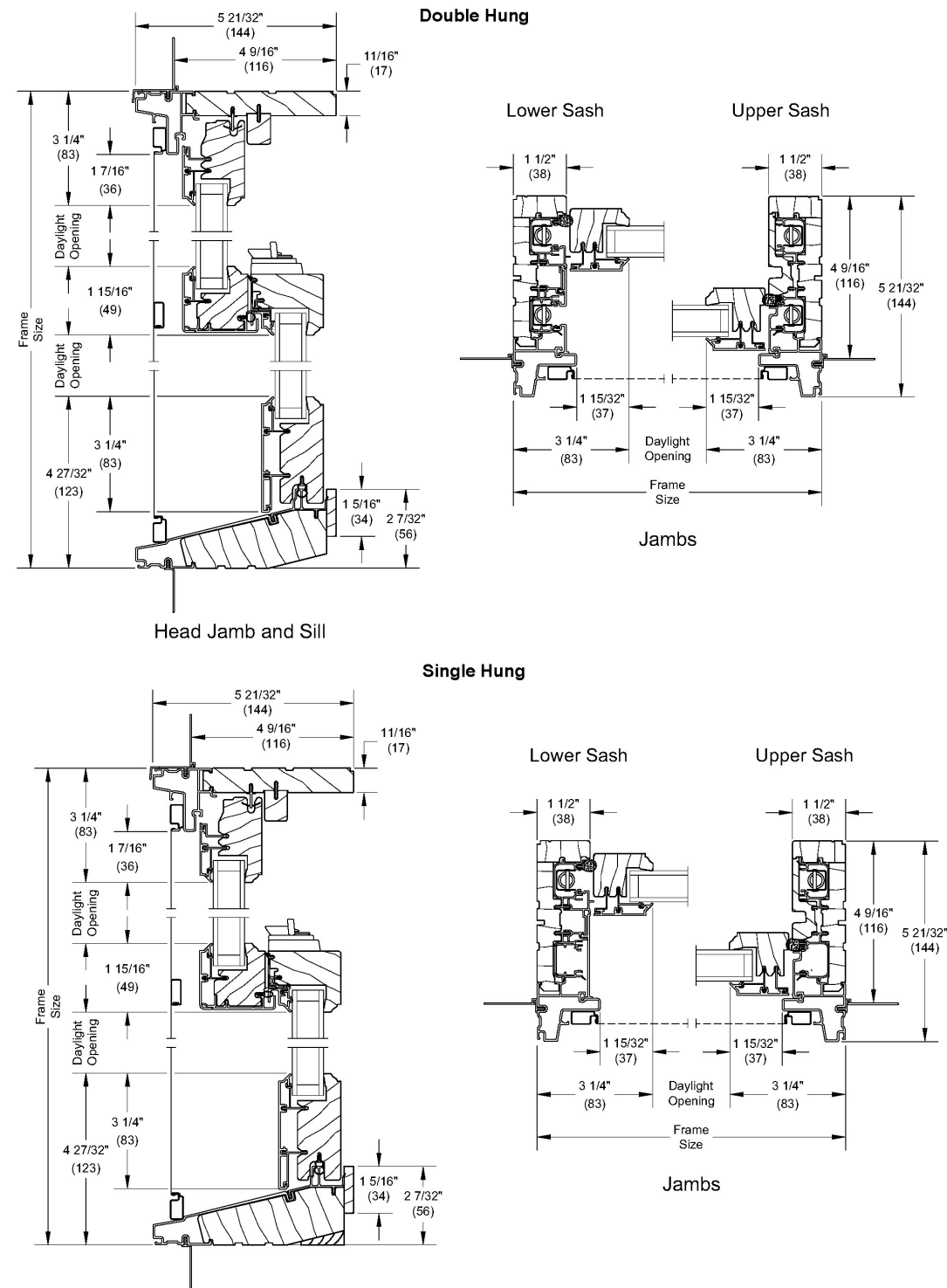

MARVIN SIGNATURE[®] ULTIMATE

Clad Color Options

Our low maintenance clad-wood products feature an extruded aluminum exterior finish paint. Because our finish meets the toughest American Architectural Manufacturers Assc richest and boldest hues to resist fading and chalking even in harsh sun or extreme weat muted, earthy tones to bold, rich colors and three pearlescent finishes. Custom color ma

The American Architectural Manufacturers Association (AAMA) awards certifications to r simulate the harsh conditions that a finish will encounter throughout the life of the windc AAMA verification provides independent verification that our finishes are best-in-class.

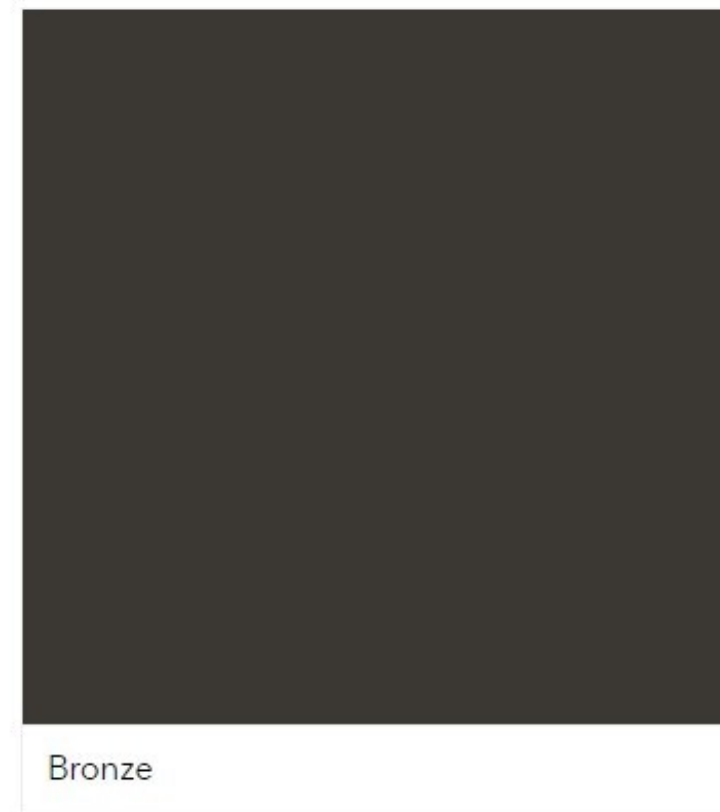

Selected: Bronze





Slateline[®]

Bold shadow lines and tapered cut-outs create the look of slate at a fraction of the cost.

★★★★★ 4.7 (26) [WRITE A REVIEW](#)



All Products **Your Area** Address ⓘ Enter your address

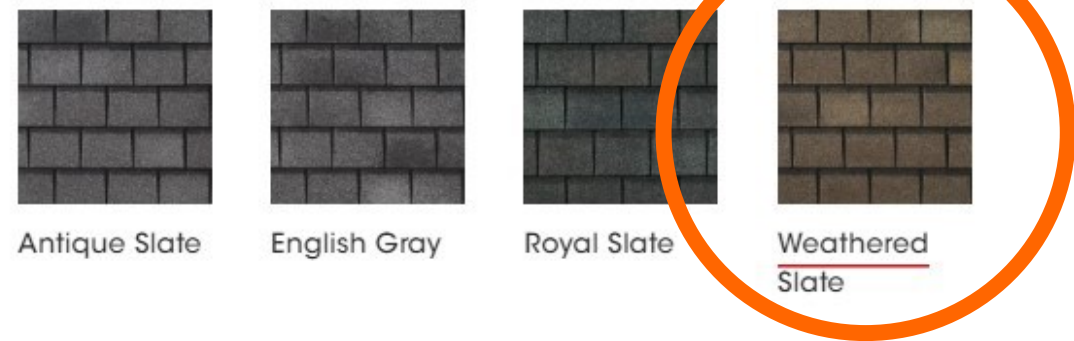

Antique Slate

English Gray

Royal Slate

Weathered Slate

Existing House: Architectural Fiberglass Shingle Roofing

Remodeling and Additions
27 North Riverview Street Dublin, Ohio

RICHARDTAYLOR
ARCHITECTS

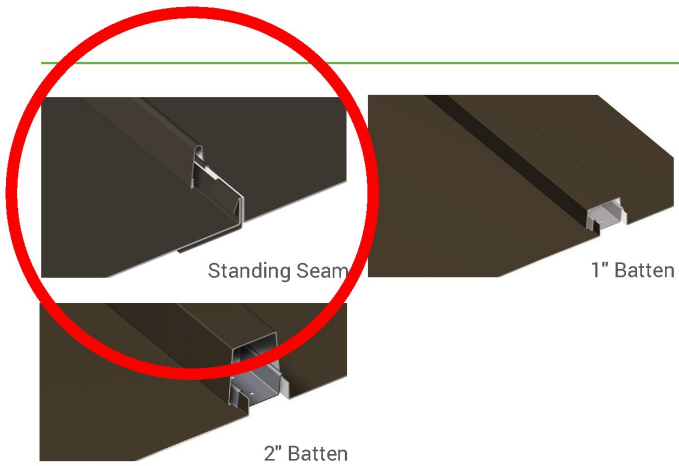

PC™ SYSTEM

SKU: Panel: PCP110, PCP120, PCP150, PCP999
 Seam: PCS114
 Batten: PCB001, PCB002
 Copper: PCP147

MATERIAL

.032, .040 aluminum
 24, 22* ga. metallic coated steel
 24 ga. 55% Al-Zn alloy coated steel with acrylic coating
 16 oz. copper* (PCP147 only)

PANEL SPECS

Coverage: 11 1/4", 12 5/8", 14 5/8"**, 15 1/4"
 Custom widths available*
 **Copper and Dark Bronze Anodized only
 Minimum Length: 2'-0" for straight, 3'-0" for curved
 Standing Seam: 1"
 Batten Seam: 1" x 1 1/2" or 2" x 1 1/2"

AVAILABLE

Straight, Tapered, Stretch Curved* (Convex and Concave)
 *Available in standing seam only

TEXTURE

Smooth or Stucco Embossed

MINIMUM SLOPE

3:12

www.atas.com/pc

STOCK COLORS

70% PVDF resin based coatings provide high-performance durability for exterior and interior applications. These coatings are designed to resist fading, chalking, and abrasion. Meets the requirement of AAMA 2605-13 for aluminum substrates.

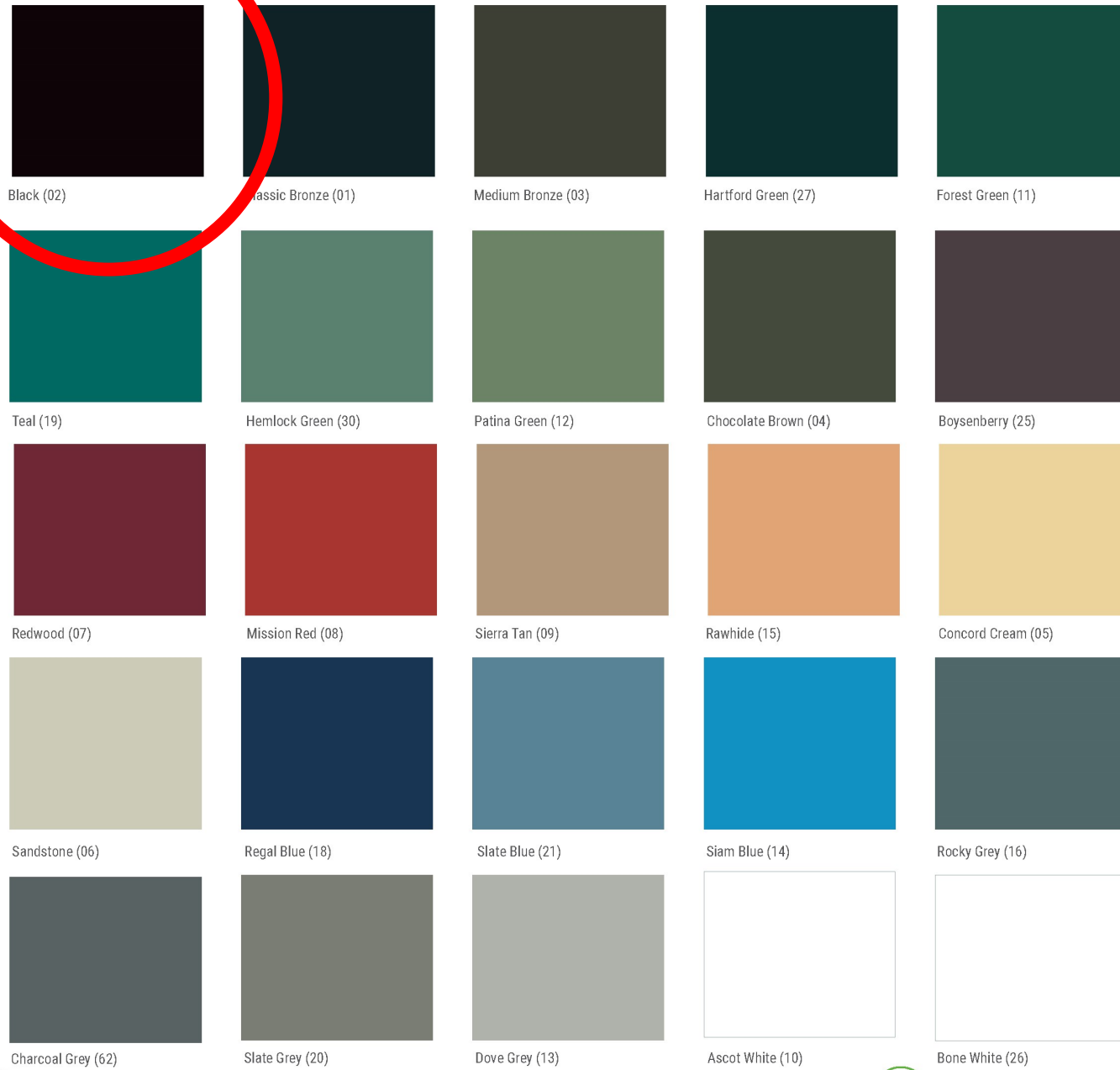

www.atas.com/colors

2 | www.atas.com

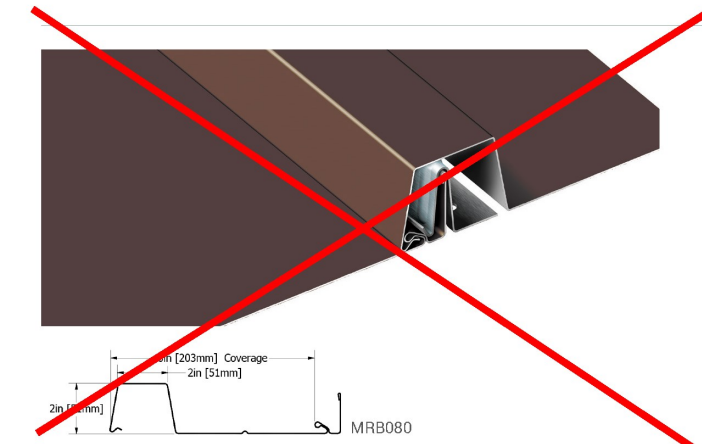
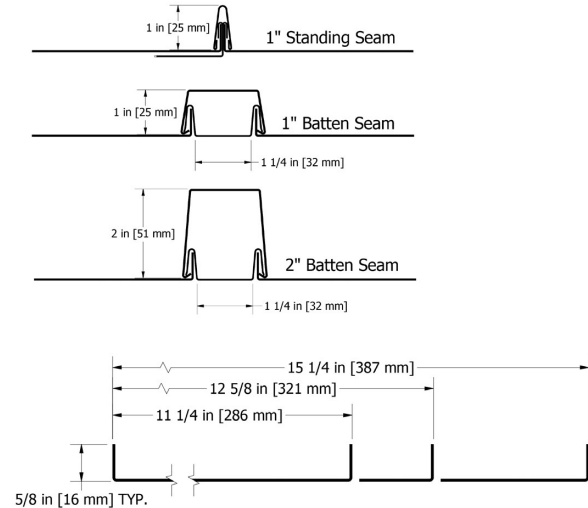

MONARCH™ BATTEN SEAM

SKU: MRB080, MRB120, MRB160

MATERIAL

.032, .040, .050* aluminum
 24, 22* ga. metallic coated steel
 24 ga. 55% Al-Zn alloy coated steel with acrylic coating*
 16, 20 oz. copper*

PANEL SPECS

Coverage: 8", 12", 16"
 (stiffening ribs standard, specify without)
 Minimum Length: 4'-0"
 Seam Height: 2"

TEXTURE

Smooth or Stucco Embossed

MINIMUM SLOPE

2:12

www.atas.com/monarch

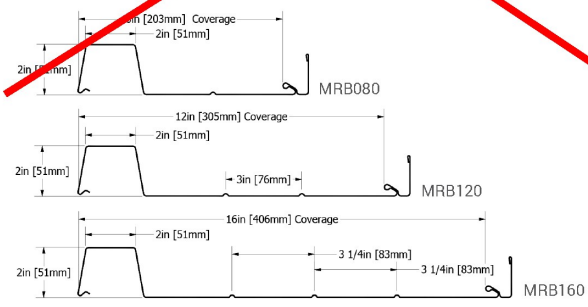

New Addition: Standing Seam Roof



Gutters and Downspouts
 6" half-round copper gutter
 4" round copper downspouts

Curb-Mounted Skylights

Size Chart and Codes

Venting Skylights

Model Size	2222	2234	2246	3030	3046	3434	4622	4646
Outside Curb (W"xH")	25 1/2 x 25 1/2	25 1/2 x 37 1/2	25 1/2 x 49 1/2	33 1/2 x 33 1/2	33 1/2 x 49 1/2	37 1/2 x 37 1/2	49 1/2 x 25 1/2	49 1/2 x 49 1/2
Maximum Skylight Clearance (W"xH")	26 7/16 x 26 7/16	26 7/16 x 38 7/16	26 7/16 x 50 7/16	34 7/16 x 34 7/16	34 7/16 x 50 7/16	38 7/16 x 38 7/16	50 7/16 x 26 7/16	50 7/16 x 50 7/16
Daylight Square Feet	2.58	4.20	5.92	5.27	8.29	6.89	5.92	13.13
Fits On Center	24"	24"	24"	24"	24"	16"	16" or 24"	16" or 24"

¹ Only available in VCS.

Fixed Skylights

Custom FCM sizes available. Call for more information.

Model Size	1430	1446	2222	2230	2234	2246	2270	3030	3046	3055	3434	3446	4646	4672
Outside Curb (W"xH")	17 1/2 x 33 1/2	17 1/2 x 49 1/2	25 1/2 x 25 1/2	25 1/2 x 33 1/2	25 1/2 x 37 1/2	25 1/2 x 49 1/2	25 1/2 x 73 1/2	33 1/2 x 33 1/2	33 1/2 x 49 1/2	33 1/2 x 58 1/2	37 1/2 x 37 1/2	37 1/2 x 49 1/2	49 1/2 x 49 1/2	49 1/2 x 75 1/2
Maximum Skylight Clearance (W"xH")	18 3/8 x 34 3/8	18 3/8 x 50 3/8	26 3/8 x 26 3/8	26 3/8 x 34 3/8	26 3/8 x 38 3/8	26 3/8 x 50 3/8	26 3/8 x 74 3/8	34 3/8 x 34 3/8	34 3/8 x 50 3/8	34 3/8 x 59 3/8	38 3/8 x 38 3/8	38 3/8 x 50 3/8	50 3/8 x 50 3/8	50 3/8 x 76 3/8
Daylight Square Feet	3.07	4.68	3.52	4.77	5.39	7.27	11.01	6.46	9.85	11.76	8.27	11.14	15.02	23.35
Fits On Center	16"	16"	24"	24"	24"	24"	24"	24"	24"	24"	16"	16"	16" or 24"	16" or 24"

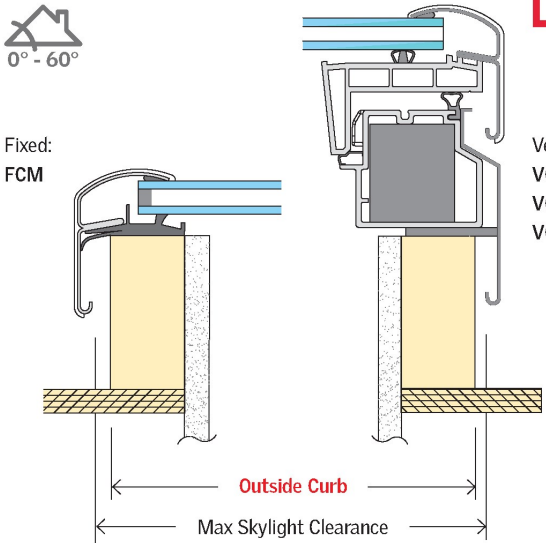

- FCM - Fixed skylight
- VCM - Manual venting skylight
- VCE - Electric venting skylight
- VCS - Solar Powered "Fresh Air" skylight

VCM 1446 2 0 04

Model	Sizes	Interior finish	Cladding	Glazings
FCM	1430"	0 None (FCM)	0 Aluminum	04 Clean, Quiet & Safe glass
VCM	1446"	2 White	9 Special	05 Low E ³ /Temp*
VCE	2222	9 Special		06 Impact
VCS	2230			08 White lami
	2234			14 LoE ³ -340 Lami™
	2246			15 LoE ³ -340™
	2270"			16 LoE ³ -340 Hurricane™
	3030			29 Triple Pane™
	3046			99 Special
	3050"			
	3434			
	3446"			
	4622™			
	4646			
	4672"			

*FCM only sizes
 **VCS only

Existing House and Additions: Copper Gutters and Velux Skylights

Existing House
Lap Siding
SW 7675 Sealskin

Existing House
All Trim
SW 6133 Muslin



Foundation Veneer
Glen-Gery
Cushwa 1-HB

LP SmartSide 38 Primed 0.315-in x 6-in x 192-in Engineered Lap Siding

Item #2500084 | Model #41339

Shop LP SmartSide ★★★★★ 262



Specifications: LP® SmartSide® Trim

BRUSHED SMOOTH TRIM

SMOOTH APPEARANCE, ADVANCED DURABILITY OF ENGINEERED WOOD

- Helps protect against moisture intrusion, impacts from hail, and damage from freeze/thaw cycles
- Treated with the SmartGuard® process for superior protection against many weather conditions and resistance to termites and fungal decay
- 16' length can result in faster installation and fewer seams
- Primed for exceptional paint adhesion
- Backed by an industry-leading 5/50-year limited warranty



Brushed Smooth Trim

Existing House: Lap Siding, Trim, and Brick Veneer

Remodeling and Additions
27 North Riverview Street Dublin, Ohio

RICHARDTAYLOR
ARCHITECTS

THERMORY Brands Solutions Product Catalog Resources Blog **REQUEST A SAMPLE**

q Benchmark Ash
Cladding 1x4 T/G (JEM)

USE: Exterior, Interior	APPLICATION: Cladding
MODIFICATION STRENGTH: Intense	FINISH: Unolled
TEXTURE: Smooth	COLOR: Brown
BRAND: Benchmark Ash	SPECIES: White Ash
PROFILE: T&G	COVERAGE: 3.5 in
WIDTH: 3.7 in	THICKNESS: .79 in
INSTALLATION TYPE: Visible	INSTALLATION METHOD: Screw

REQUEST A CONSULTATION

MDM STONEWORKS Home Product Lines Gallery Services Contact

MDM STONEWORKS, INC.

Timberwolf - Craft Orchard Limestone

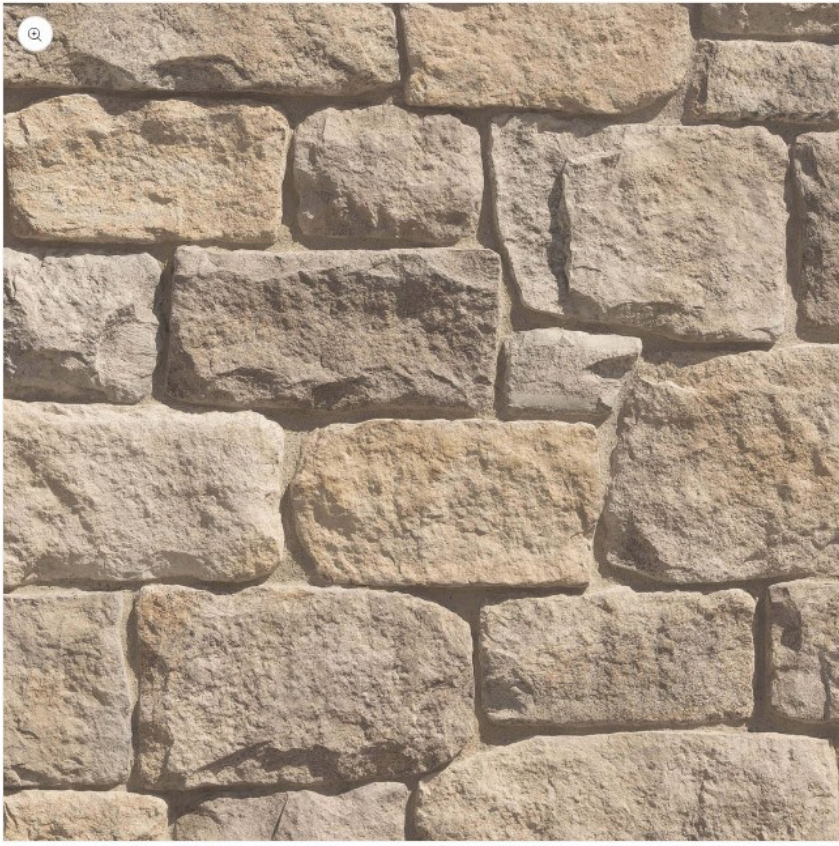

Style

- Flats - 10 square feet
- Flats - 100 square feet
- Corners - 7 linear feet
- Corners - 65 linear feet

Creative Mines Craft Orchard Limestone

ASHWOOD
on Thermally Modified Ash



CUTEK COLORTONE
Color-Protect Finish with CUTEK EXTREME UV

1.25 FL OZ - 35.23 ML
CUTEKSTAIN.COM

Specifications: LP® SmartSide® Trim

BRUSHED SMOOTH TRIM

SMOOTH APPEARANCE, ADVANCED DURABILITY OF ENGINEERED WOOD

- Helps protect against moisture intrusion, impacts from hail, and damage from freeze/thaw cycles
- ProtectGuard® process for superior protection against many and resistance to termites and fungal decay
- Enables faster installation and fewer seams
- Ensures excellent paint adhesion
- Includes a leading 5/50-year limited warranty



Brushed Smooth Trim

New Addition All Trim
Trim: SW 7675 Sealskin

Addition: Vertical Siding, Trim, and Manufactured Stone Veneer

REJUVENATION

- Account
- Track Order
- Favorites
- Cart

- New & Featured
- Ideas & Inspiration
- Collaborations
- Sustainability
- Contract Grade
- Lighting & Fans
- Hardware
- Furniture
- Outdoor
- Mirrors & Decor
- Rugs
- Kitchen
- Bath
- Organization
- Vintage
- Sal

- Extra 20% Off Clearance**
Use Code: EXTRA20 >
- Free Shipping On Our Favorites**
Shop Now >
- Front Porch Refresh**
Shop Lighting, Hardware, Planters & More >

Outdoor > Outdoor Wall Lighting

DIMENSIONS

- ADA Compliant Projection: Yes
- Fixture Width without Shade: 5"
- Length / Height with Shade: 18"
- Length / Height without Shade: 18"
- Adjustable Height: No
- Projection without Shade: 4"
- Projection with Shade: 4"
- Canopy/Base Diameter: 4.69"
- Fixture Weight: 5.8 lbs.
- Socket Type: Integrated LED
- Dimmable: Yes
- Voltage: 120V
- Power Source: Hardwired
- Articulating: No
- UL Listing: Wet
- Max. Wattage Per Socket: 60WE
- Lumen: 750
- Kelvins: 3000K
- Lifespan: 20,000 hours
- Fixture Width with Shade: 5"

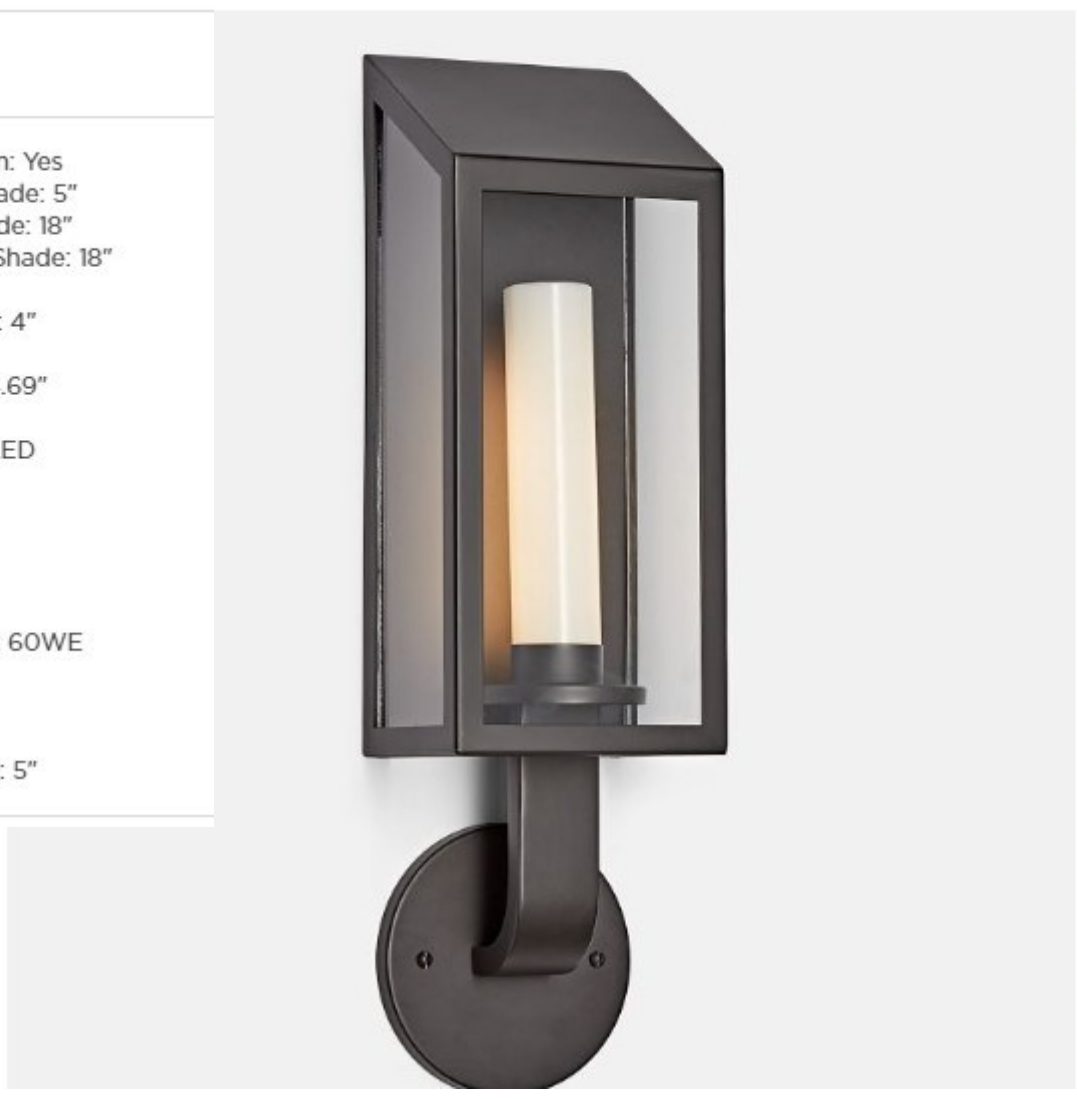

BESTSELLER

Lombard Lantern Small LED Wall Sconce

Clearance
 \$249.99 - \$589 ~~\$549 - \$589~~

- Show All
- On Sale

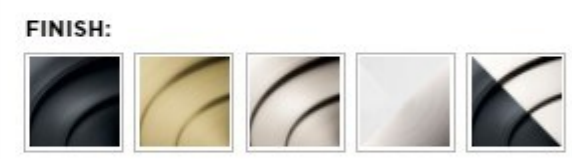

- 0 +

Extra 20% Off Clearance with Code: EXTRA20

DELIVERY & PICKUP OPTIONS

Make a selection to view options.

Ship This Item

ADD TO CART

FREE DESIGN APPOINTMENT

ADD TO FAVORITES Design Question?
START A FREE DESIGN C

AEGEAN PEARL PAVERS

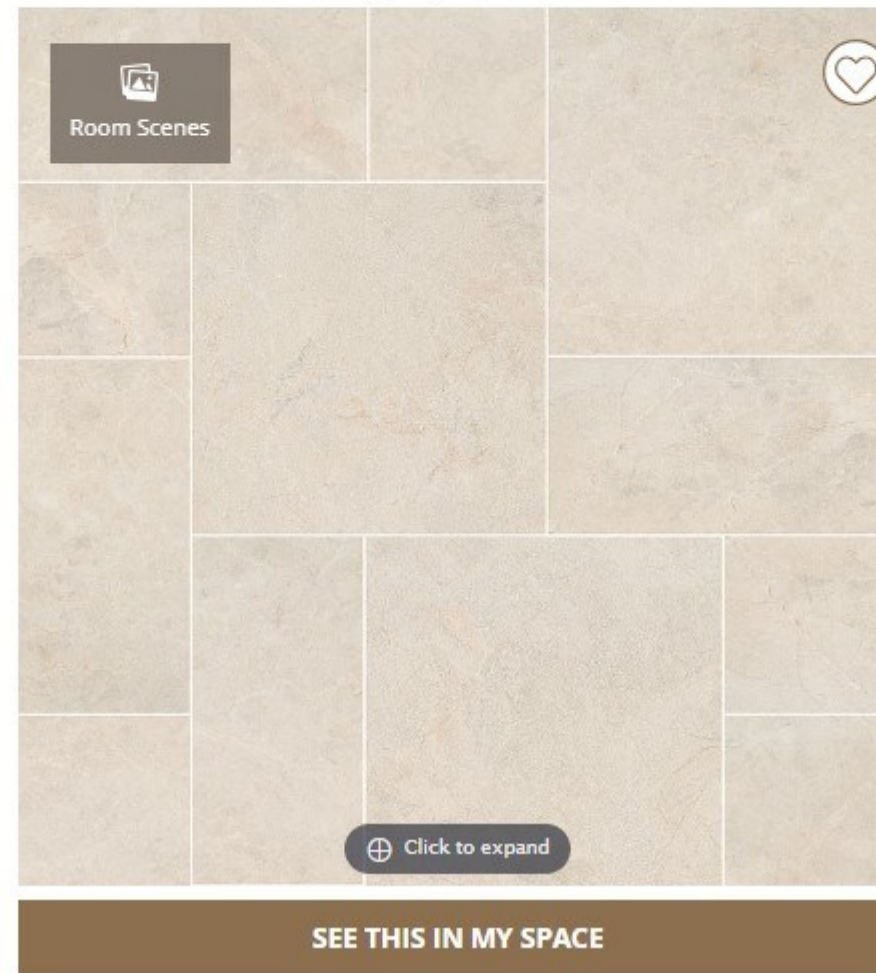
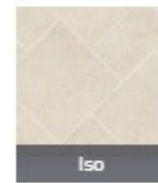
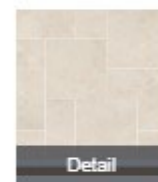
[ABOUT](#) [SIZES](#) [DOWNLOADS](#)

Description:
Aegean Pearl texture a
This tumbled marble v
delivers an undeniable
These pavers are avail
recommended for inte

[Click to expand](#)[SEE THIS IN MY SPACE](#)

Front Walk and Back Stoop
Glen-Gery
Cushwa 1-HB (Pavers)

Front Walk and Rear Stoop (Brick) and Covered Side Patio (Pavers)



Garage Bi-Fold Doors
Tungsten Royce
Custom Wood Doors
Color: Ashwood
Material: Thermally Modified Ash

ASHWOOD
on Thermally Modified Ash

Garage Door