

**MOUNT CARMEL HEALTH SYSTEM (MCHS)
DUBLIN CAMPUS FINAL DEVELOPMENT PLAN
AMENDMENT
NOVEMBER 22, 2024**

Amendment Narrative

Narrative..... page 1

Package One – Signage Package Revisions

Original FDP Building Sign Quantities & Types page 2
Amended FDP Building Sign Quantities & Types..... page 3
Original FDP WL-02 Secondary Building ID Sign..... page 4
Amended FDP WL-02 Secondary Building ID Sign page 5
Original FDP WL-03 Secondary Building ID Sign..... page 6
Amended FDP WL-03 Secondary Building ID Sign page 7
Original FDP WL-03 Secondary Building ID Sign Detail..... page 8

Package Two – Chapel Cross Uplighting

Site Plan page 9
Lighting Fixture Cutsheet..... page 10-11

Amendment Narrative

Signage Description

Sign WL-02 Secondary Building ID Sign on South Elevation:

The amended FDP proposes the reduction in size of the “burst” logo to accommodate the addition of “Mount Carmel” lettering to be consistent with institutional brand standards. The total area of the proposed sign is 198 SF (21’-5” x 9’-3”), within the allowable 350 SF size limitation, and proportional to the building elevation.

- Allowable total signage area according to approved PUD text: 350 SF
- Total signage area graphically depicted in approved FDP: 124SF (15’-10” x 7’-10”) with “burst” logo only
- Total signage area listed in approved FDP: 96 SF

Sign WL-03 Secondary Building ID Sign at West Elevation:

The amended FDP proposes a total signage area of 97 SF (15’-5” x 6’- 4”) based upon refinement of fabrication drawings to be consistent with institutional brand standards.

- Allowable total signage area according to approved PUD text: 350 SF
- Total signage area graphically depicted in approved FDP: 97.11SF (15’-4” x 6’-4”) with “burst” logo and “Mount Carmel” lettering
- Total signage area listed in approved FDP: 46 SF

Lighting Description

An important feature of the Mount Carmel Dublin Health Campus is the chapel, centrally located between the main hospital and medical office building. Mount Carmel desires to include exterior uplighting to the chapel cross, which sits atop the chapel façade. Due to the cross rising above the building façade, a backlit or halo effect is not achievable. As such, a single light fixture located at grade level is being proposed in order to illuminate the cross at night. The fixture is over 500’ from the nearest condo at Inverness, and is shielded from view by the medical office building. The fixture is also over 900’ away from the nearest house along Bright Road, and would be substantially shielded by the landscaping both around the chapel and throughout the site.

MOUNT CARMEL HEALTH SYSTEM
SIGN QUANTITIES



462 S Ludlow St.
 Columbus, Ohio, 43215

t: 614.621.2796

www.mkskstudios.com

Site Signs - Parameters & Quantities

Sign Code	Sign Name	City of Dublin Ordinance Type	Mounting Type	Location	Illumination	ft ²	Qty.
SE-01	Primary Site Entry Sign	Site Entry Sign	Ground	Site Entry - Emerald Parkway	Internal	50	1
SE-02	Secondary Site Entry Sign	Site Entry Sign	Ground	Site Entry - Sawmill Rd. & Bright Rd.	Internal	34	2
DR-01	Primary Directional Sign	Primary Directional Sign	Ground	Internal Site Loop Road	Internal	28	2
DR-02	Secondary Directional Sign	Secondary Directional Sign	Ground	Site Entry - Emerald Parkway & Internal Site Loop Road	Internal	16	7
DR-03	Secondary Directional Sign	Secondary Directional Sign	Ground	Internal Site	External	4	33
DR-04	Secondary Directional Sign	Secondary Directional Sign	Ground	Bright Rd. Site Entry & Internal Site Loop Road	N/A	9	2

Client:



Project:

**Mount Carmel Northwest Health
 Campus
 Wayfinding Signage System**

**Project Number: C22524
 Wayfinding Signage System**

Building Signs - Parameters & Quantities

Sign Code	Sign Name	City of Dublin Ordinance Type	Mounting Type	Location	Illumination	ft ²	Qty.
BE-01	Building Entrance Sign	Building Entrance Sign	Wall/Canopy	Main & Medical Office Building Entries	Internal	50	2
BE-02	Building Entrance Sign - ER	Building Entrance Sign	Wall/Canopy	ED & Ambulance Entries	Internal	34	2
WL-01	Primary Building ID Sign	Building ID Sign - Wall Sign	Wall	Building Equipment Screen	Internal	350	2
WL-02	Secondary Building ID Sign	Building ID Sign - Wall Sign	Wall	Building Facade	Internal	96	1
WL-03	Secondary Building ID Sign	Building ID Sign - Wall Sign	Wall	Building Facade	Internal	46	1

Exterior Signage Design Updates
 Issued For Coordination & Discussion

06.20.2022

Revisions:

Design Intent

Sign Name

GENERAL - SIGN QUANTITIES &
 TYPES

MOUNT CARMEL HEALTH SYSTEM
SIGN QUANTITIES



462 S Ludlow St.
 Columbus, Ohio, 43215

t: 614.621.2796
www.mkskstudios.com

Site Signs - Parameters & Quantities

Sign Code	Sign Name	City of Dublin Ordinance Type	Mounting Type	Location	Illumination	ft ²	Qty.
SE-01	Primary Site Entry Sign	Site Entry Sign	Ground	Site Entry - Emerald Parkway	Internal	50	1
SE-02	Secondary Site Entry Sign	Site Entry Sign	Ground	Site Entry - Sawmill Rd. & Bright Rd.	Internal	34	2
DR-01	Primary Directional Sign	Primary Directional Sign	Ground	Internal Site Loop Road	Internal	28	2
DR-02	Secondary Directional Sign	Secondary Directional Sign	Ground	Site Entry - Emerald Parkway & Internal Site Loop Road	Internal	16	7
DR-03	Secondary Directional Sign	Secondary Directional Sign	Ground	Internal Site	External	4	33
DR-04	Secondary Directional Sign	Secondary Directional Sign	Ground	Bright Rd. Site Entry & Internal Site Loop Road	N/A	9	2

Building Signs - Parameters & Quantities

Sign Code	Sign Name	City of Dublin Ordinance Type	Mounting Type	Location	Illumination	ft ²	Qty.
BE-01	Building Entrance Sign	Building Entrance Sign	Wall/Canopy	Main & Medical Office Building Entries	Internal	50	2
BE-02	Building Entrance Sign - ER	Building Entrance Sign	Wall/Canopy	ED & Ambulance Entries	Internal	34	2
WL-01	Primary Building ID Sign	Building ID Sign - Wall Sign	Wall	Building Equipment Screen	Internal	350	2
WL-02	Secondary Building ID Sign	Building ID Sign - Wall Sign	Wall	Building Facade	Internal	198	1
WL-03	Secondary Building ID Sign	Building ID Sign - Wall Sign	Wall	Building Facade	Internal	97	1

Client:



Project:

Mount Carmel Northwest Health
 Campus
 Wayfinding Signage System

Project Number: C22524
 Wayfinding Signage System

11.22.2024

Revisions:

Amended Final Development Plan

Sign Name
 GENERAL - SIGN QUANTITIES &
 TYPES

Client:



Project:

Mount Carmel Northwest Health
Campus
Wayfinding Signage System

Project Number: C22524
Wayfinding Signage System

Exterior Signage Design Updates
Issued For Coordination & Discussion

06.20.2022

Revisions:

Elevation Updated 07.13.2022

Design Intent

Set Out

Sign Name

Secondary Building ID Sign

Wall

WL-02

Notes:

1. Internally illuminated sign mounted to building's base structure (see sign layout for details).
Top of sign to align with the top of the adjacent curtain wall.
2. Metal clad facade.
3. Curtain wall.

Signage Parameters:

- Overall Sign Dimensions - 15'-10" x 7'-10"
- Total Signage Area - 96 ft²
- Height from Grade - 59'-4" (to top of sign)

WL-02-001

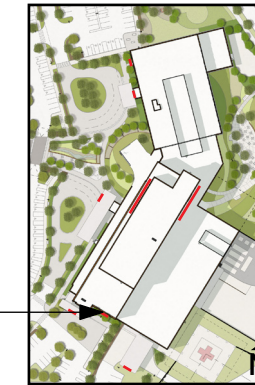

Locations

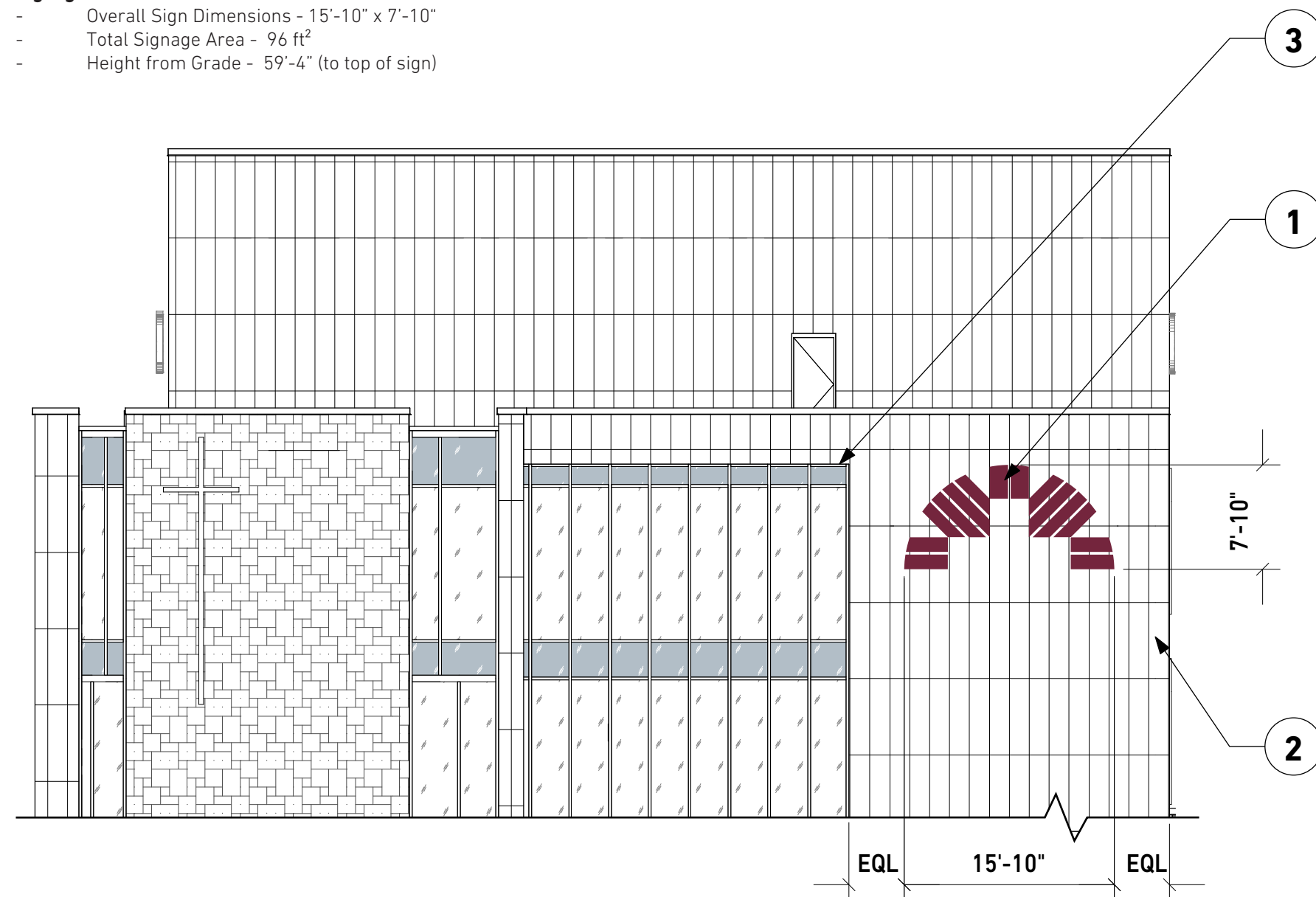

01 Secondary Building ID Sign- South Elevation
Scale: 1:128

Client:

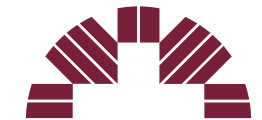

MOUNT CARMEL
A Member of Trinity Health

Project:

Mount Carmel Northwest Health
Campus
Wayfinding Signage System

Project Number: C22524
Wayfinding Signage System

11.22.2024

Revisions:

**Amended Final Development
Plan
Set Out**

Sign Name

Secondary Building ID Sign

Wall

WL-02

Notes:

1. Internally illuminated sign mounted to building's base structure (see sign layout for details).
Top of sign to align with the top of the adjacent curtain wall.
2. Metal clad facade.
3. Curtain wall.

Signage Parameters:

- Overall Sign Dimensions - 9'-3" x 21'-5"
- Total Signage Area - 198 ft²
- Height from Grade - 58'-0" (to top of sign)

WL-02-001

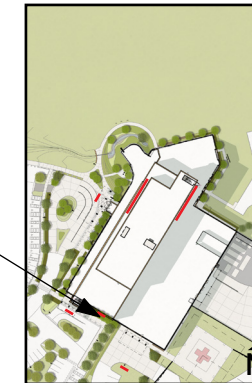

Locations

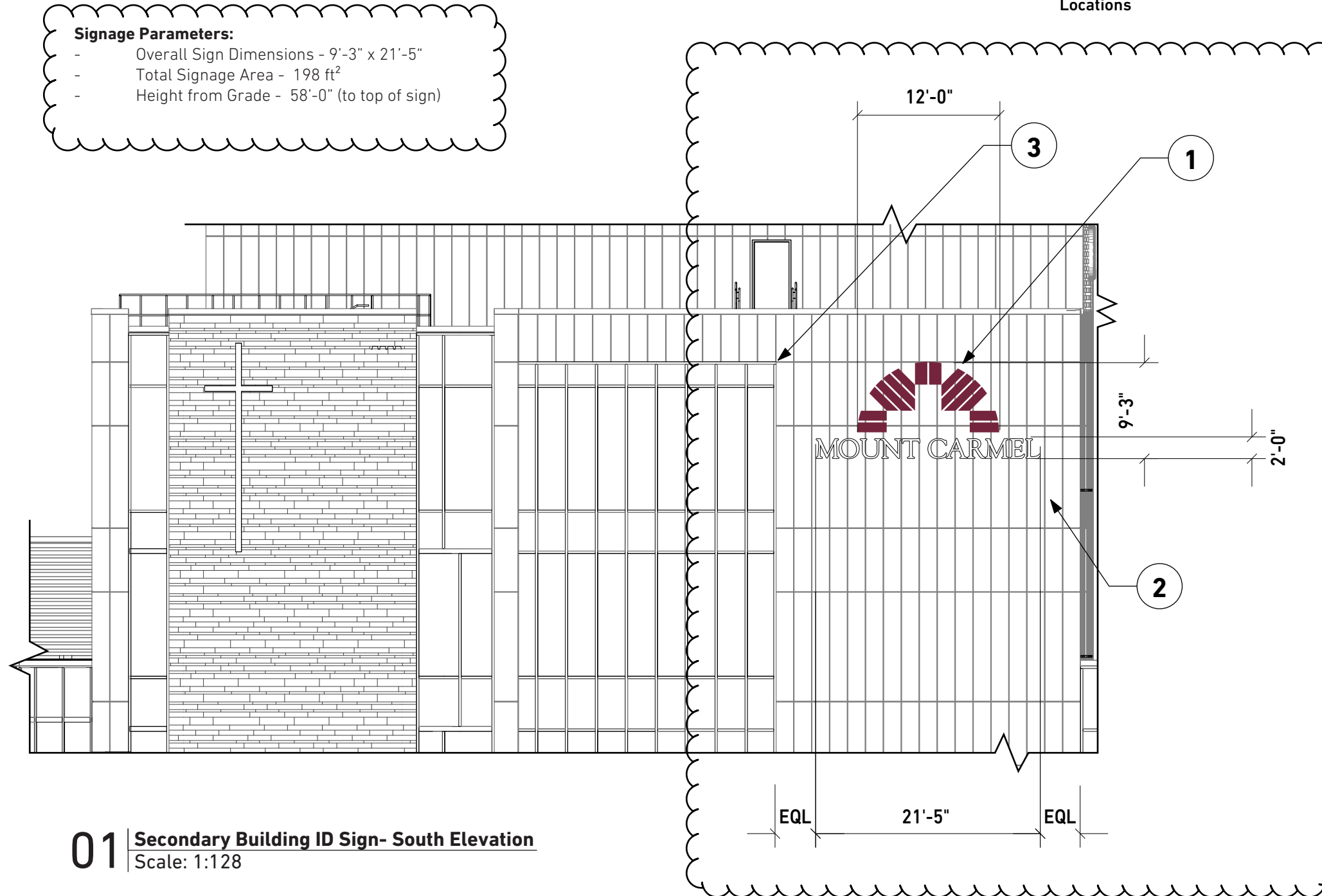

01 Secondary Building ID Sign- South Elevation
Scale: 1:128

Client:

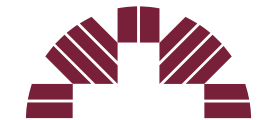

MOUNT CARMEL

A Member of Trinity Health

Project:

**Mount Carmel Northwest Health
Campus
Wayfinding Signage System**

Project Number: C22524
Wayfinding Signage System

**Exterior Signage Design Updates
Issued For Coordination & Discussion**

06.20.2022

Revisions:

Elevation Updated 07.13.2022

Design Intent

Set Out

Sign Name

Secondary Building ID Sign

Wall

WL-03

WL-03-001

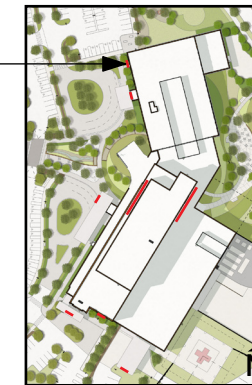

Locations

Notes:

1. Internally illuminated sign mounted to building facade (see sign layout for details).
2. Internally illuminated sign mounted to building facade (see sign layout for details).
3. Masonry Facade.

Signage Parameters:

- Overall Sign Dimensions - 15'-4" x 6'-4"
- Total Signage Area - 46 ft²
- Height from Grade - 29'-0" (to top of sign)

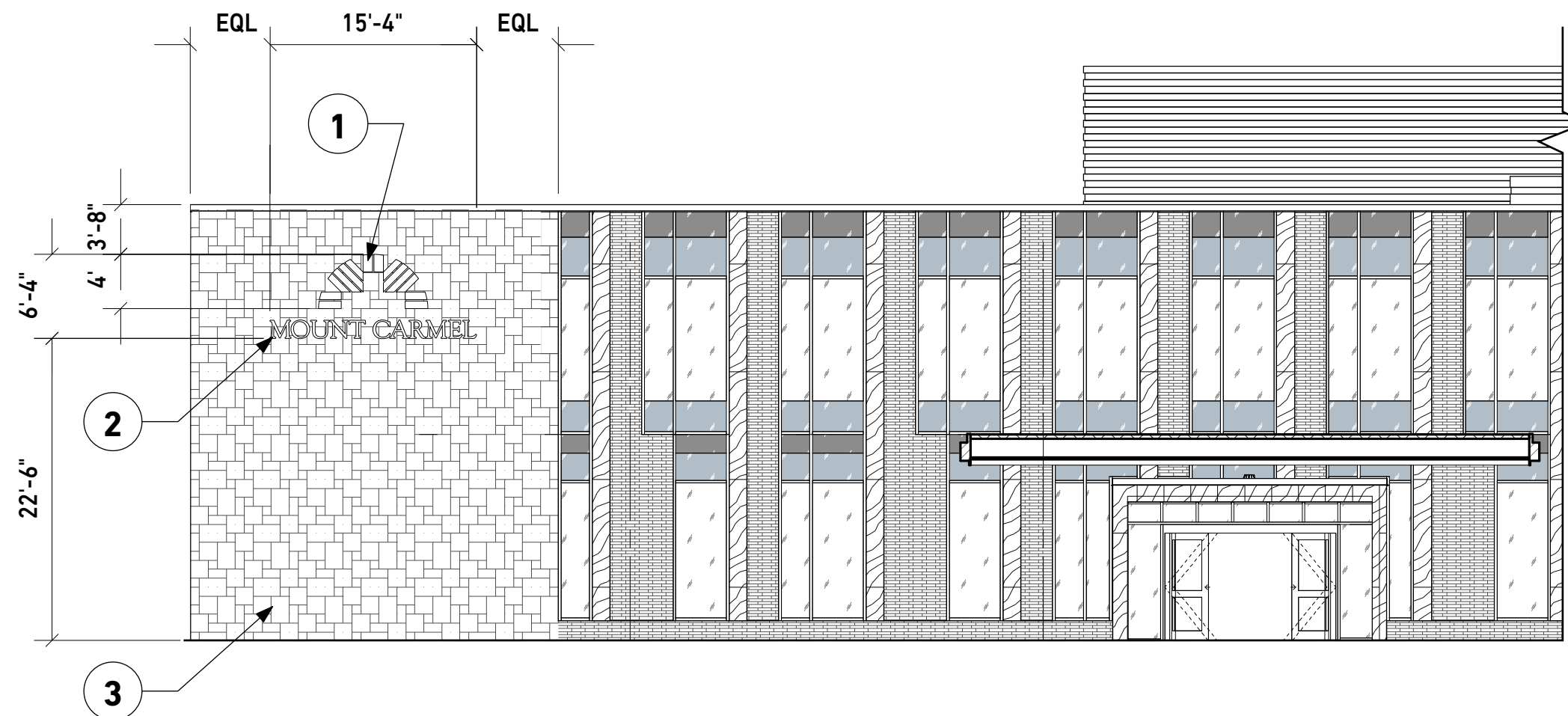

01 | **Secondary Building ID Sign- West Elevation**
Scale: 1:128

Client:



MOUNT CARMEL

A Member of Trinity Health

Project:

Mount Carmel Northwest Health
Campus
Wayfinding Signage System

Project Number: C22524
Wayfinding Signage System

11.22.2024

Revisions:

**Amended Final Development
Plan
Set Out**

Sign Name

Secondary Building ID Sign

Wall

WL-03

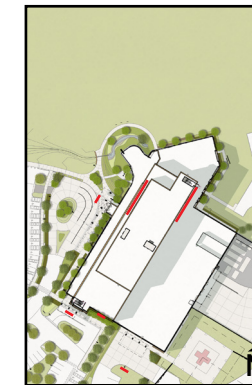

Locations

Notes:

1. Internally illuminated sign mounted to building facade (see sign layout for details).
2. Internally illuminated sign mounted to building facade (see sign layout for details).
3. Masonry Facade.

Signage Parameters:

- Overall Sign Dimensions - 15'- 5" x 6'- 4"
- Total Signage Area - 97 ft²
- Height from Grade - 29'-0" (to top of sign)

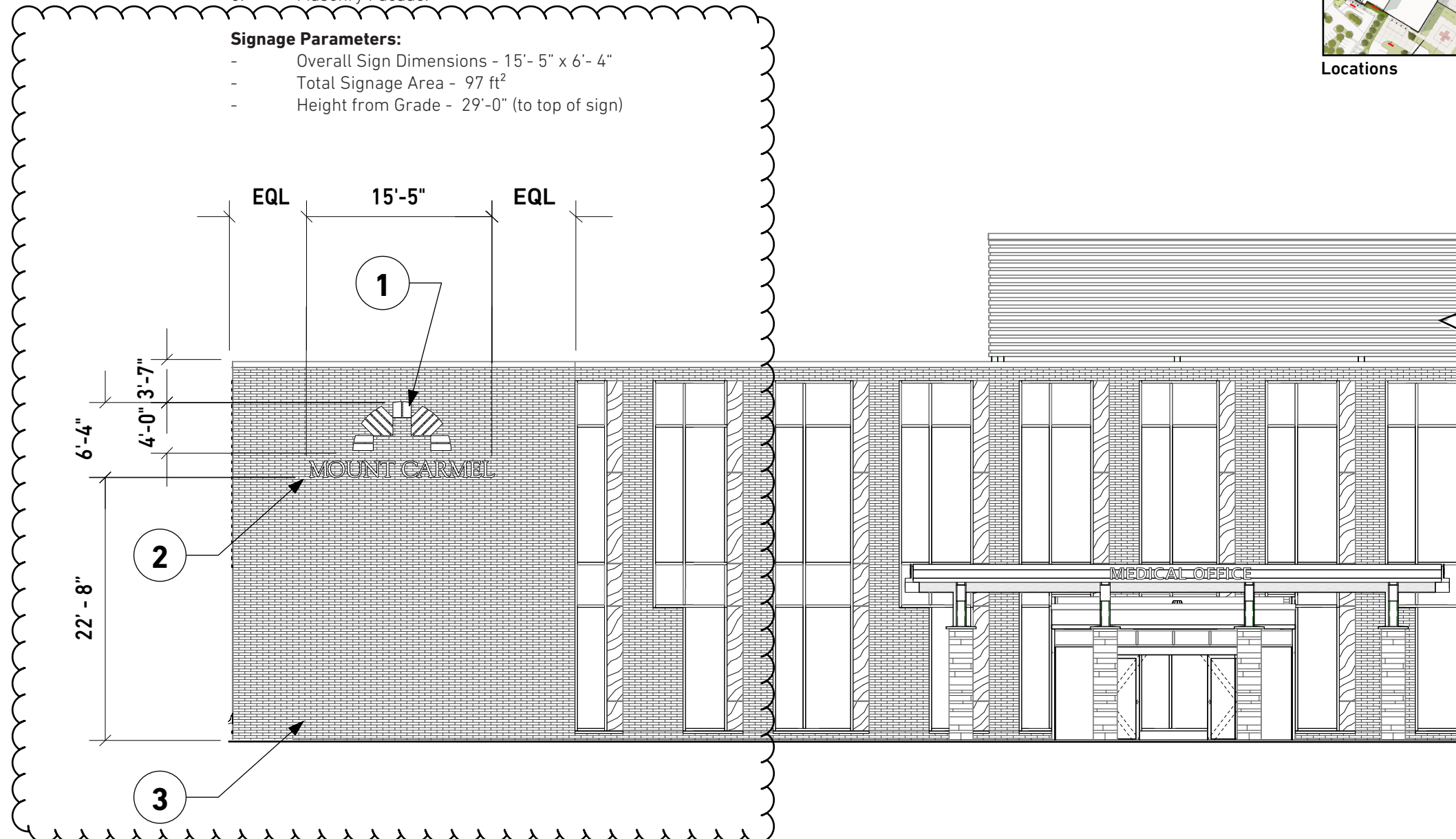

01 Secondary Building ID Sign- West Elevation
Scale: 1:128

Client:

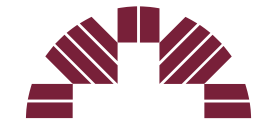

MOUNT CARMEL
A Member of Trinity Health

Project:

**Mount Carmel Northwest Health
Campus
Wayfinding Signage System**

**Project Number: C22524
Wayfinding Signage System**

**Exterior Signage Design Updates
Issued For Coordination & Discussion**

06.20.2022

Revisions:

Design Intent

Detail

Sign Name

Secondary Building ID Sign

Wall

WL-03

Notes:

1. Internally illuminated individual aluminium letters and logo with opal acrylic faces. Sign White by day, illuminating white by night.
2. Aluminum sides and back with white 2Pac Polyurethane satin paint finish to match MP05780.
3. Letters and logo fixed to building structure through facade cladding. Details TBD.
4. Removable face frame.
5. Building Facade.

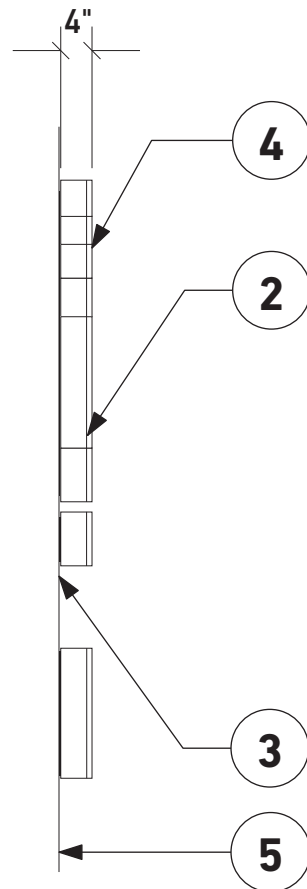

02 End View
Scale: 1:24

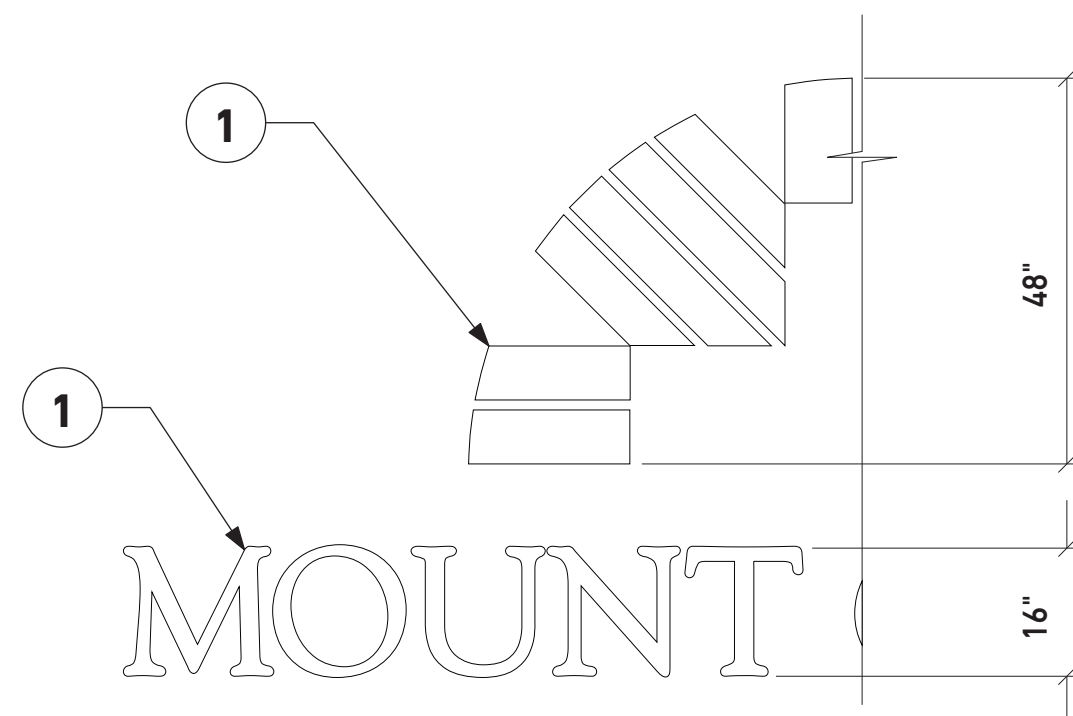

01 Front View
Scale: 1:24

General Notes:

Sign contractor to ensure sign structure, footings and fixings are fit for purpose.
All footings and fixation methods to be certified by a qualified structural engineer licensed to practice in the state of Ohio.

Author: 3/17/2023 1:00:38 PM Autodesk Docs://North-Central-MS-Dublin-Hospital.LAND_MKSK.Dublin_center_4231.rvt

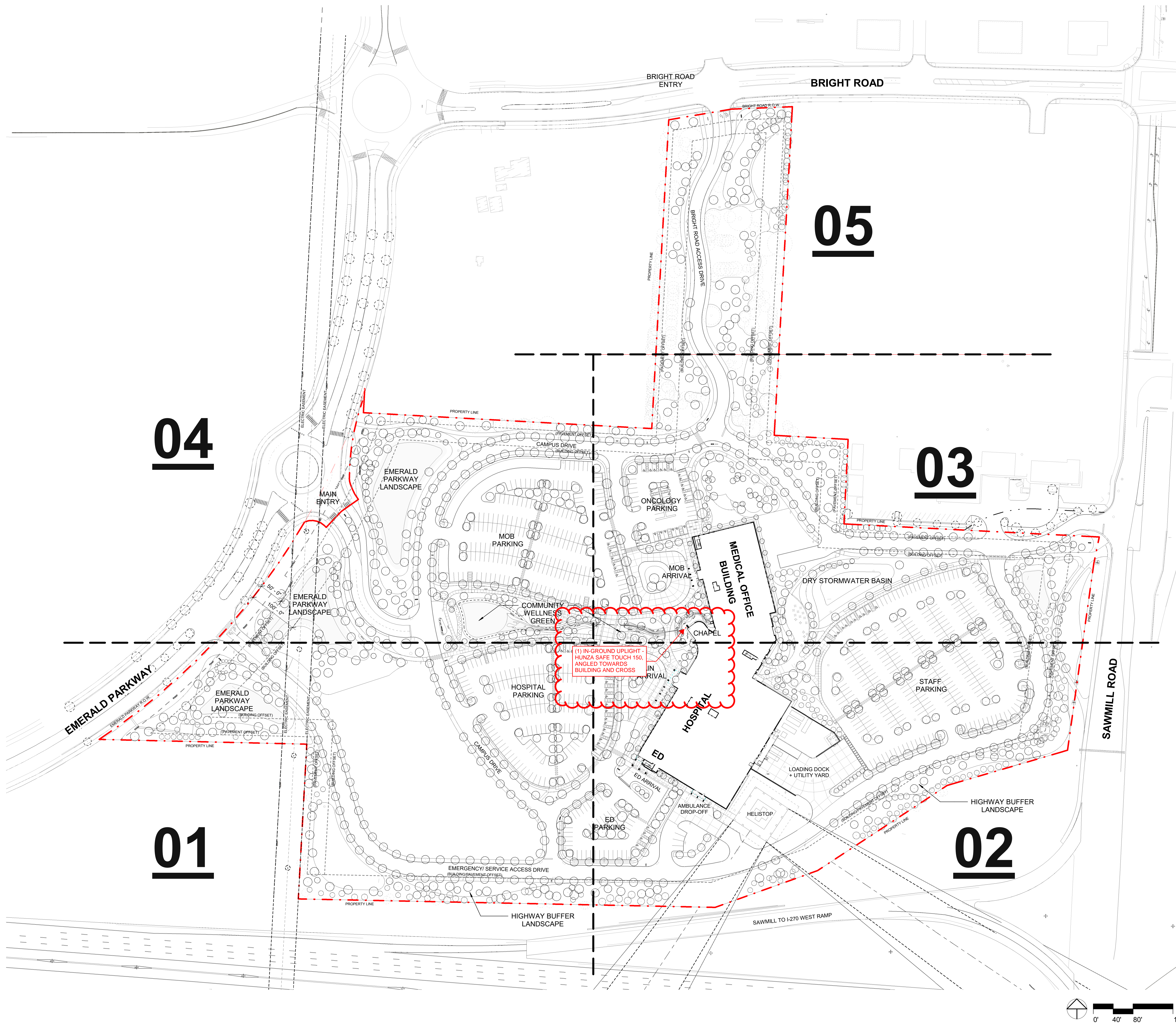

HGA

333 East Erie Street
 Milwaukee, Wisconsin 53202
 Telephone 414.278.8200

KORDA

KORDA, NEMETH ENGINEERING
 CIVIL/MECHANICAL/ELECTRICAL/
 PLUMBING/STRUCTURAL/
 TECHNOLOGY ENGINEER

KORDA
 1650 WATERMARK DRIVE
 COLUMBUS, OH 43215
 614.487.1650

MKSK

LANDSCAPE ARCHITECT

MKSK
 462 SOUTH LUDLOW ALLEY
 COLUMBUS, OH 43215
 614.621.2796

**MOUNT CARMEL
 HEALTH
 SYSTEM**



NORTHWEST HEALTH
 CAMPUS
 4105 EMERALD
 PARKWAY
 DUBLIN, OH



NO	DESCRIPTION	DATE

ISSUANCE HISTORY - THIS SHEET

HGA NO: 1927-004-00

KEY PLAN

DATE: MARCH 17, 2023

**SITE ENGINEERING
 PACKAGE**

L002

SITE ENGINEERING PACKAGE

SafeTouch™ 150

PROJECT:
TYPE:
SOURCE:
NOTES:

SPECIFICATIONS IK10 IP68

LED Chip	Cree CXB 2540 field replaceable LED board
Luminaire Output*	5000 Lumens @ 1400 (52watts)
Lumens Per Watt*	90 Lumens minimum @ 52 watts
CRI (3000K)	80 Standard, 90+ Optional
LED Life Expectancy	50,000 hours L70
Colour Temperatures	2700K, 3000K, 4000K, 3000K (90+ CRI)
Beam Angles	22, 33, 51
Ingress Protection	IP68 *not for use in pool or ponds
Inverse Kinematics Rating	IK10
Maximum Load	2000kgs (4400lbs)
Warranty	Electronics = 5 years Aluminium Body = 5 years Stainless Steel Flange = 10 years Solid Bronze Flange = 10 years
Standards	BS/EN 60598.2.2 cUL 1598 CE
B Number	94.05

*Delivered from the Luminaire with unobstructed beam



ST150/DB
Direct Burial Model

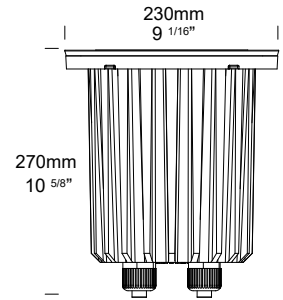

Direct Burial Model
ST150/DB



ST150/SC
Canister Model

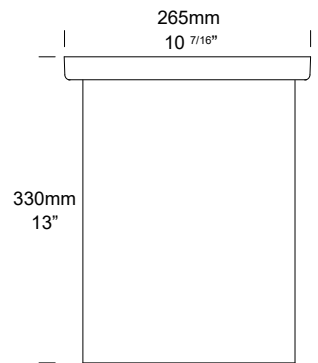

Canister Model (standard)
ST150/SC

PRODUCT CONFIGURATION

Please fill in appropriate codes into boxes provided

Cat. No. ST150

Luminaire	Power	Material/ Flange	Beam	Colour	Accessories
<input type="text" value="ST150/SC"/> Canister Model	<input type="checkbox"/> SR Series Remote - 1400mA Input, 52W Output <input type="checkbox"/> R Retro® - 120-277 VAC Input Parallel Wired	<input type="checkbox"/> SBZ Solid Bronze Flange <input type="checkbox"/> SS Stainless Steel Flange	<input type="checkbox"/> 22 22° <input type="checkbox"/> 33 33° <input type="checkbox"/> 51 51°	<input type="checkbox"/> 2 2700K <input type="checkbox"/> 3 3000K <input type="checkbox"/> 4 4000K <input type="checkbox"/> 39 3000K, 90+ CRI	<input type="checkbox"/> HCL/ST150 Hex Cell Louvre <input type="checkbox"/> GS15 Glare Shield <input type="checkbox"/> ISNT Internal Snoot <input type="checkbox"/> LENST150FR Frosted Lens <input type="checkbox"/> LENST150CAS Anti Slip Lens <input type="checkbox"/> CJK Cable Joint Kit
<input type="text" value="ST150/DB"/> Direct Burial Model					

SR
Series Remote Driver
Constant current driver (included, not installed).
Individual fixtures require:
37VDC @1400mA
0-10V Dimming

R
Retro® 110-277VAC Driver
Integrated constant current driver (included).
Input: 120, 240, 277 VAC
Output: 60 Watts total
37VDC @ 1400mA
(Dimming option available 0-10V)

Additional Comments:

*Due to continued product enhancements, specifications may change without notification.

LUMINAIRE CONSTRUCTION

CNC machined from one of the following metals:

Body - Cast from virgin high corrosion resistant, low copper content (0.001%) aluminium alloy. Finished with chromate substrate, Epoxy layer and a UV resistant polyester powder coat colour.

Colour - Black.

Flanges - Machined from either

Solid Brone 260mm x 6mm (10 1/4" x 1/4")

316 Stainless Steel 260mm x 6mm

(10 1/4" x 1/4")

All fixings are made from 316 Stainless Steel

Cable:

Water resistant rubber SWOOJ cable with HUNZA™ Anti-Syphon™ barrier system

Gaskets:

Silicone, iron impregnated 220°C (428°F).

Step Lens:

12mm (1/2") extra clear, low iron, shatter resistant glass.

Lifetime warranty.

Adjustability:

The gimbal is fully adjustable, allowing 360° rotation and 0-20° elevation.

Mounting:

The ST150 is available with a double layer coated alloy mounting canister for casting into the ground or into concrete.

Maximum drive over speed 10 kp/h (6mp/h) with a maximum load rating of 2000kgs (4400lbs).

Luminaire Weight:

Stainless Steel 10kg (22lbs 1oz)

Solid Bronze 11kg (24lbs 4oz)



ACCESSORIES

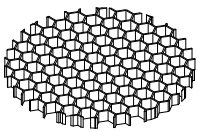

Hex Cell Louvre

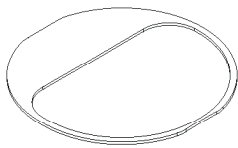

Glare Shield

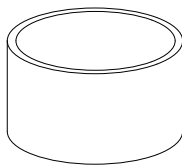

Internal Snoot

BEAM ANGLES

High efficiency Reflectors. Field replaceable

IES files available for download: hunzalighting.com/downloads

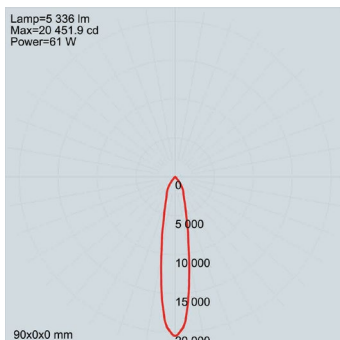

22° FWHM REFLECTOR

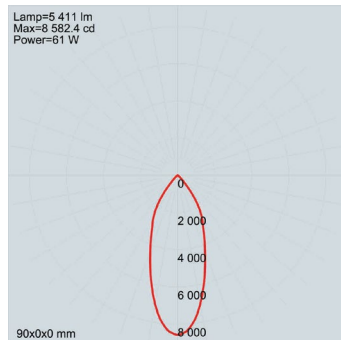

33° FWHM REFLECTOR

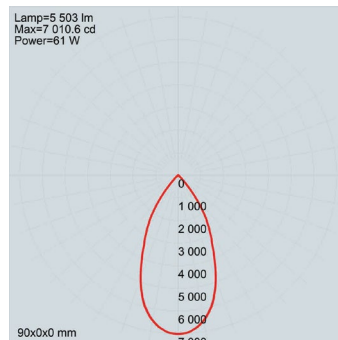

51° FWHM REFLECTOR

WIRING GUIDE

Available for download: hunzalighting.com/downloads

NOTE: Diagrams are a guide only, wire colours and polarity may change depending on fixture and country.

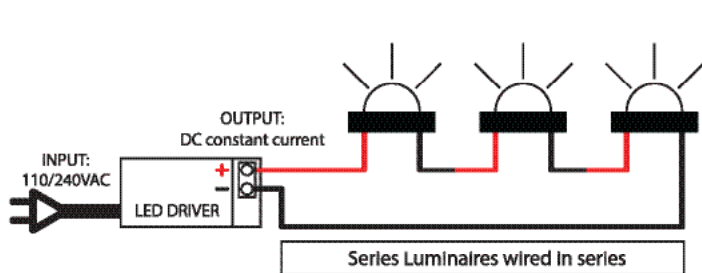

Series/Remote Driver

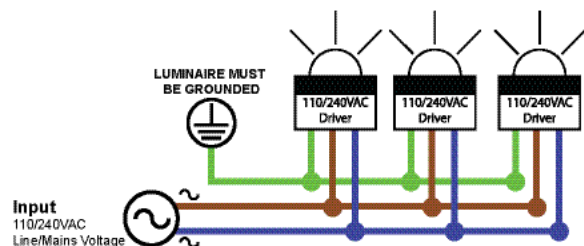

Retro® - 120-277 VAC Driver

*Due to continued product enhancements, specifications may change without notification.



HUNZA LIGHTING
130 Felton Mathew Ave
Saint Johns
Auckland 1072
New Zealand

Ph: +64-9-528-9471
hunza@hunza.co.nz
www.hunzalighting.com

INTERNATIONAL CONTACTS:
www.hunzalighting.com/contact

This document contains proprietary information of Hunza™. Its receipt or possession does not convey any rights to reproduce or disclose its content.