

SITE PLAN
SCALE: 1/8" = 1'-0"

Custom Home For
Paul and Kathie Ghidotti
185 S. Riverview St.
Dublin, Ohio 43017

RTA Project Number
CH0320

	Date
Preliminary	000000
Bidding	000000
Construction	000000

Revision	Date
	000000

This Drawing And This Design Are The Copyrighted Property Of Richard Taylor Architects And May Not Be Reproduced, Altered, Or Otherwise Used In Any Manner Without The Written Consent Of Richard Taylor Architects

This Drawing Is Not To Be Submitted For Permits Without The Architect's Seal Below

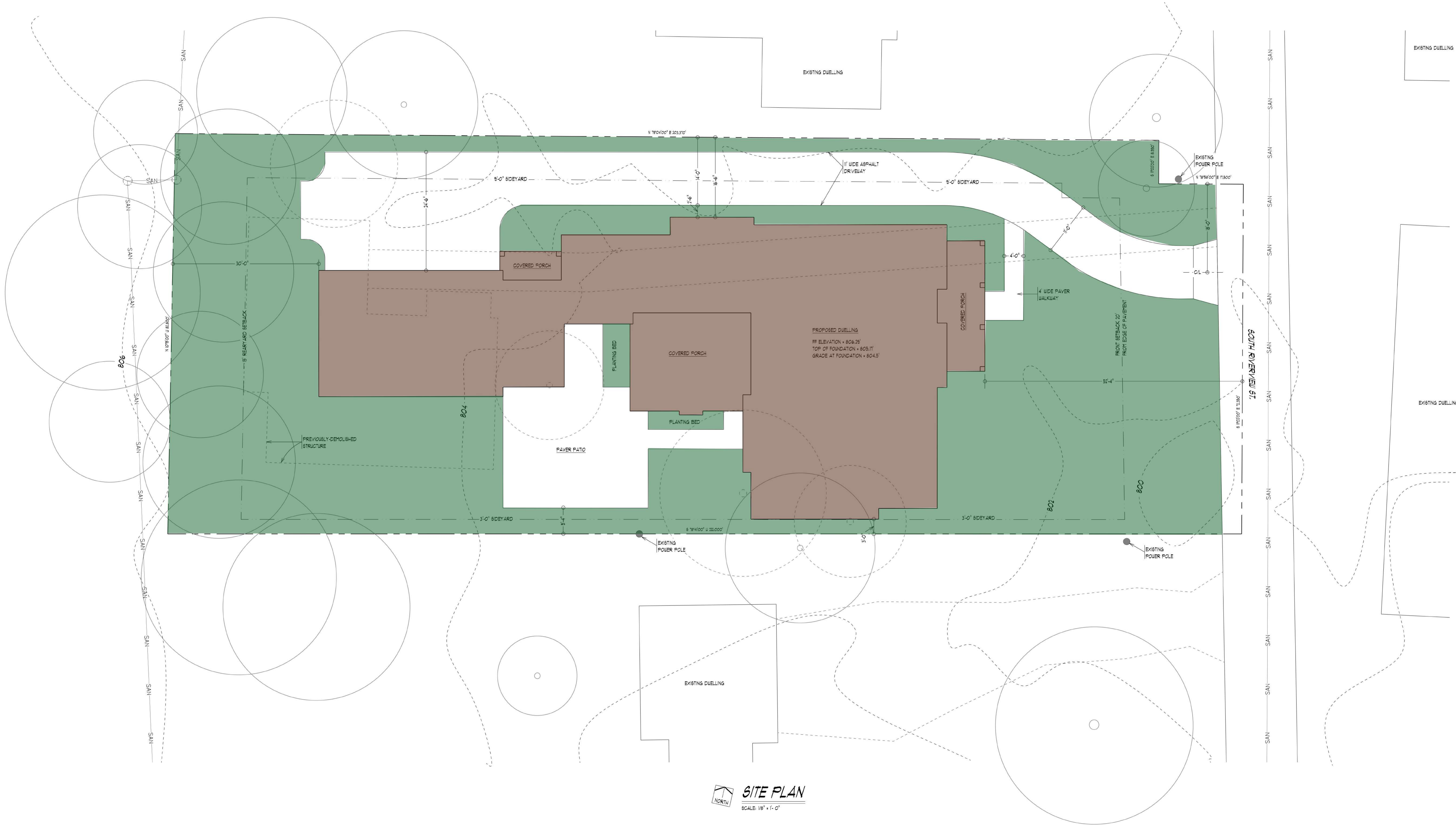

SITE PLAN
SCALE: 1/8" = 1'-0"

Custom Home For
Paul and Kathie Ghidotti
185 S. Riverview St.
Dublin, Ohio 43017

RTA Project Number
CH0320

	Date
Preliminary	000000
Bidding	000000
Construction	000000

Revision	Date
	000000

This Drawing And This Design Are The Copyrighted Property Of Richard Taylor Architects And May Not Be Reproduced, Altered, Or Otherwise Used In Any Manner Without The Written Consent Of Richard Taylor Architects

This Drawing is Not To Be Submitted For Permits Without The Architect's Seal Below

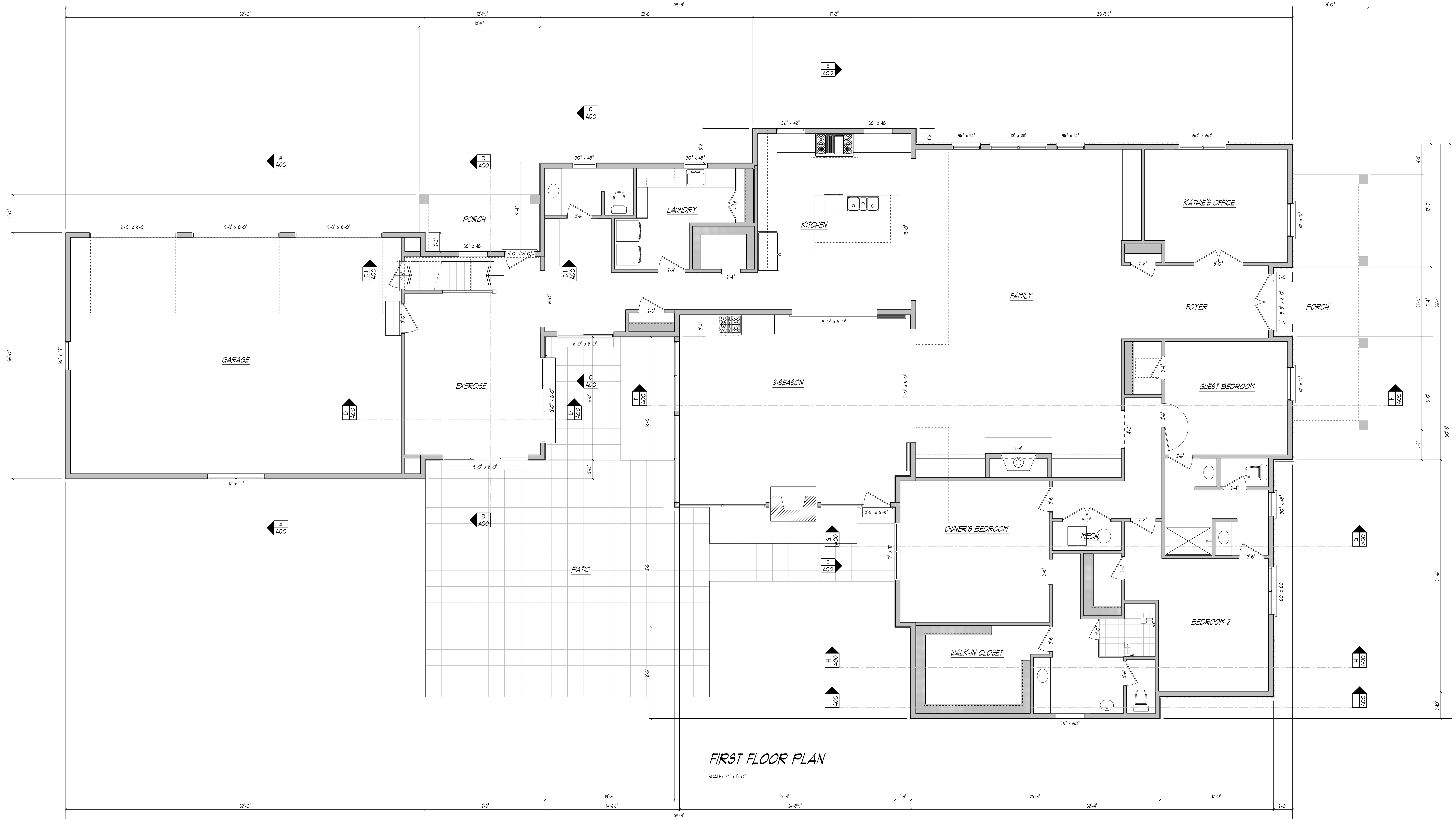

FIRST FLOOR PLAN

SCALE: 1/4" = 1'-0"

Custom Home For
Paul and Kathie Ghidotti
185 S. Riverview St.
Dublin, Ohio 43017

RTA Project Number
CH0320

	Date
Preliminary	000000
Bidding	000000
Construction	000000

Revision	Date
	000000

This Drawing And This Design Are The Copyrighted Property Of Richard Taylor Architects And May Not Be Reproduced, Altered, Or Otherwise Used In Any Manner Without The Written Consent Of Richard Taylor Architects

This Drawing Is Not To Be Submitted For Permits Without The Architect's Seal Below

Custom Home For
Paul and Kathie Ghidotti
185 S. River View St.
Dublin, Ohio 43017

RTA Project Number
CH0320

	Date
Preliminary	000000
Bidding	000000
Construction	000000

Revision	Date
	000000

This Drawing And This Design Are The Copyrighted Property Of Richard Taylor Architects And May Not Be Reproduced, Altered, Or Otherwise Used In Any Manner Without The Written Consent Of Richard Taylor Architects

This Drawing Is Not To Be Submitted For Permits Without The Architect's Seal Below

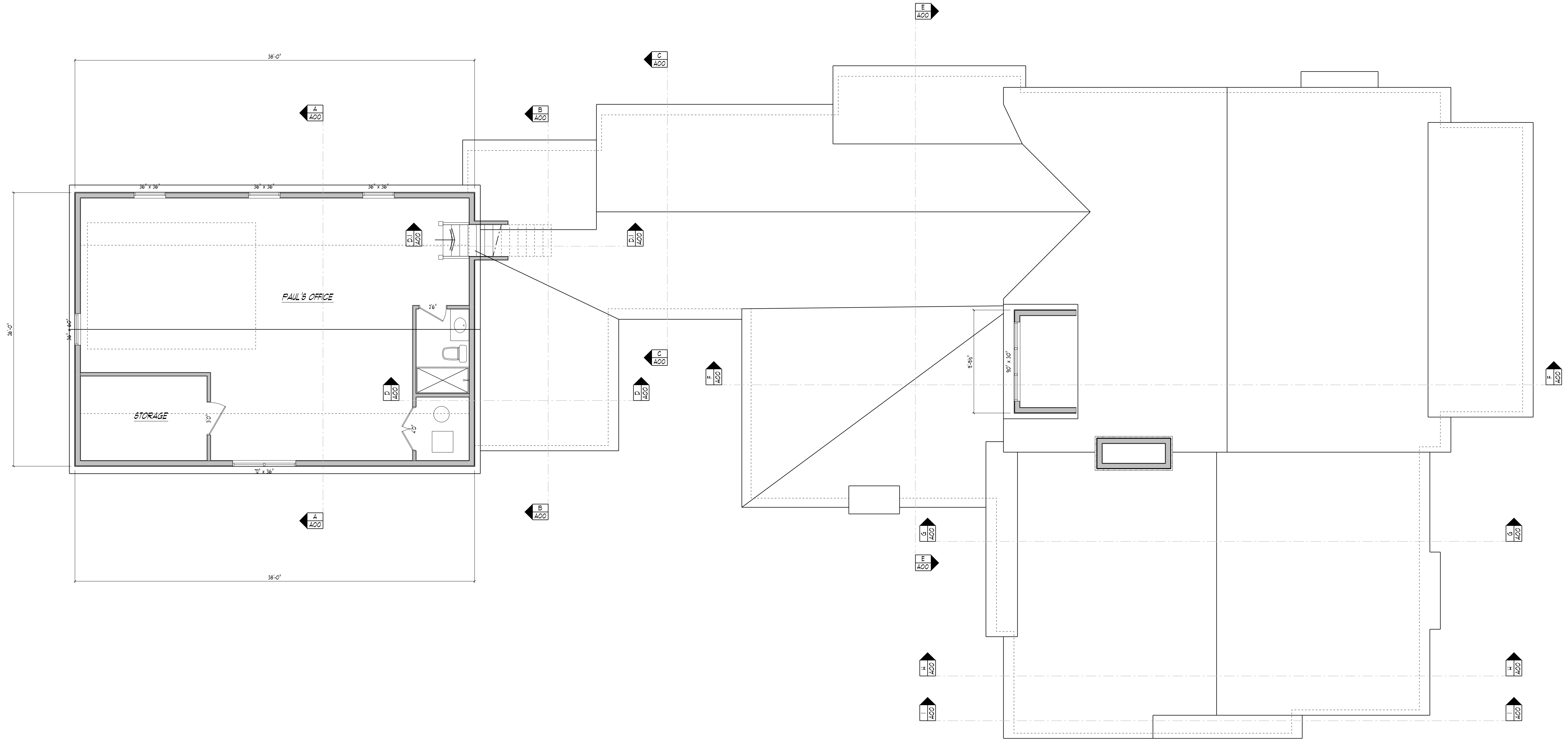

SECOND FLOOR PLAN

SCALE: 1/4" = 1'-0"



WEST ELEVATION

SCALE: 1/4" = 1'-0"



EAST ELEVATION

SCALE: 1/4" = 1'-0"

ELEVATION NOTES

ROOF/TRIM	
1	VENTED RIDGE CAP
2	PREFINISHED STANDING SEAM METAL ROOF 16" PANEL WIDTH
21	SLATE SHINGLES
22	SINGLE-PLY RUBBER MEMBRANE ROOFING
3	1" X 6" FASCIA - FIELD PAINTED
4	6" HALF-ROUND GALVANIZED STEEL CUTTER AND 4" ROUND GALVANIZED STEEL DOWNSPOUTS
5	1" X 6" FRIEZE - FIELD PAINTED
6	1" X 6" RAKE - FIELD PAINTED
WALLS/TRIM	
7	CULTURED STONE VENEER WITH BUTTERED JOINTS
71	CULTURED STONE HEAD - SEE DETAIL SHEET A00
72	CULTURED STONE SILL - SEE DETAIL SHEET A00
8	1" X 6" TONGUE AND GROOVE VERTICAL SIDING FIELD PAINTED/STAINED
9	1" X 4" CORNER TRIM - FIELD PAINTED
10	1" X 2" TRIM - FIELD PAINTED
11	HEAD TRIM (SEE DETAIL) - FIELD PAINTED
12	2" X SILL - FIELD PAINTED
13	CUSTOM WOOD BRACKET - FIELD PAINTED SEE DETAIL SHEET A00
14	BUILT-UP WOOD COLUMN - SEE DETAIL SHEET A00
15	BUILT-UP WOOD BEAM - SEE DETAIL SHEET A00
16	SCREENED PANEL
17	24" X 48" CUSTOM WOOD GABLE VENT WITH SCREENING - FIELD PAINTED
18	1" X WOOD TRIM - FIELD PAINTED
MISC	
19	CUT LIMESTONE PORCH
20	CUT LIMESTONE SLAB STEP
21	STONE CHIMNEY CAP - SEE DETAIL SHEET A00
22	COMPOSITE OVERHEAD DOOR

Custom Home For
Paul and Kathie Ghidotti
185 S. Riverview St.
Dublin, Ohio 43017

RTA Project Number
CH0320

	Date
Preliminary	000000
Bidding	000000
Construction	000000

Revision	Date
	000000

This Drawing And This Design Are The Copyrighted Property Of Richard Taylor Architects And May Not Be Reproduced, Altered, Or Otherwise Used In Any Manner Without The Written Consent Of Richard Taylor Architects

This Drawing Is Not To Be Submitted For Permits Without The Architect's Seal Below

Custom Home For
Paul and Kathie Ghidotti
185 S. Riverview St.
Dublin, Ohio 43017

RTA Project Number
CH0320

	Date
Preliminary	000000
Bidding	000000
Construction	000000

Revision	Date
	000000

This Drawing And This Design Are The Copyrighted Property Of Richard Taylor Architects And May Not Be Reproduced, Altered, Or Otherwise Used In Any Manner Without The Written Consent Of Richard Taylor Architects

This Drawing is Not To Be Submitted For Permits Without The Architect's Seal Below



WEST ELEVATION

SCALE: 1/4" = 1'-0"

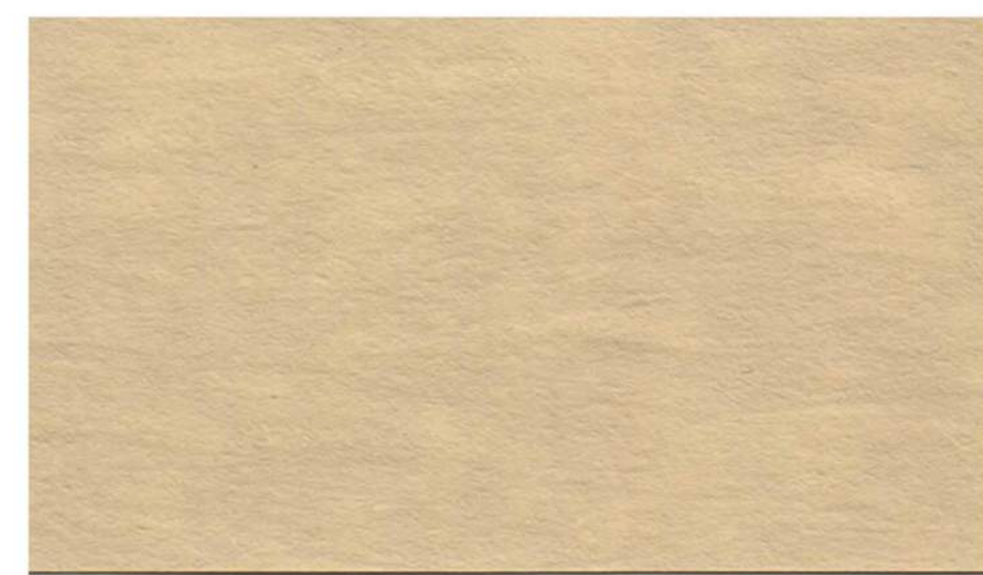

White Birch SW 3503



Mountain Ash SW 3540

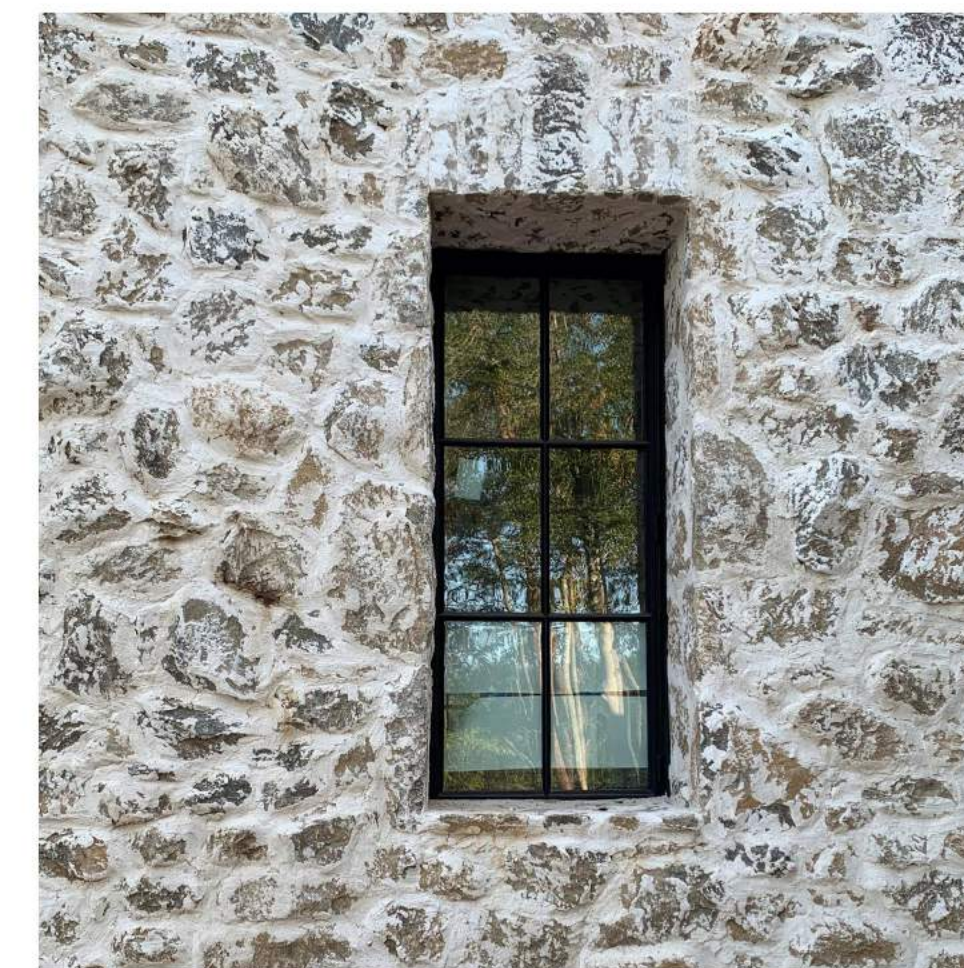

EAST ELEVATION

SCALE: 1/4" = 1'-0"

ELEVATION NOTES

- ROOF/TRIM**
- 1 VENTED RIDGE CAP
- 2 PREFINISHED STANDING SEAM METAL ROOF 16" PANEL WIDTH
- 21 SLATE SHINGLES
- 22 SINGLE-PLY RUBBER MEMBRANE ROOFING
- 3 1X6 FASCIA - FIELD PAINTED
- 4 6" HALF-ROUND GALVANIZED STEEL CUTTER AND 4" ROUND GALVANIZED STEEL DOWNSPOUTS
- 5 1X6 FRIEZE - FIELD PAINTED
- 6 1X6 RAKE - FIELD PAINTED
- WALLS/TRIM**
- 7 CULTURED STONE VENEER WITH BUTTERED JOINTS
- 71 CULTURED STONE HEAD - SEE DETAIL SHEET A00
- 72 CULTURED STONE SILL - SEE DETAIL SHEET A00
- 8 1X6 TONGUE AND GROOVE VERTICAL SIDING FIELD PAINTED/STAINED
- 9 1X4 CORNER TRIM - FIELD PAINTED
- 10 1X2 TRIM - FIELD PAINTED
- 11 HEAD TRIM (SEE DETAIL) - FIELD PAINTED
- 12 2X SILL - FIELD PAINTED
- 13 CUSTOM WOOD BRACKET - FIELD PAINTED (SEE DETAIL SHEET A00)
- 14 BUILT-UP WOOD COLUMN - SEE DETAIL SHEET A00
- 15 BUILT-UP WOOD BEAM - SEE DETAIL SHEET A00
- 16 SCREENED PANEL
- 17 2x4x4ft CUSTOM WOOD CABLE VENT WITH SCREENING - FIELD PAINTED
- 18 1X WOOD TRIM - FIELD PAINTED
- MISC**
- 19 CUT LIMESTONE PORCH
- 20 CUT LIMESTONE SLAB STEP
- 21 STONE CHIMNEY CAP - SEE DETAIL SHEET A00
- 22 COMPOSITE OVERHEAD DOOR

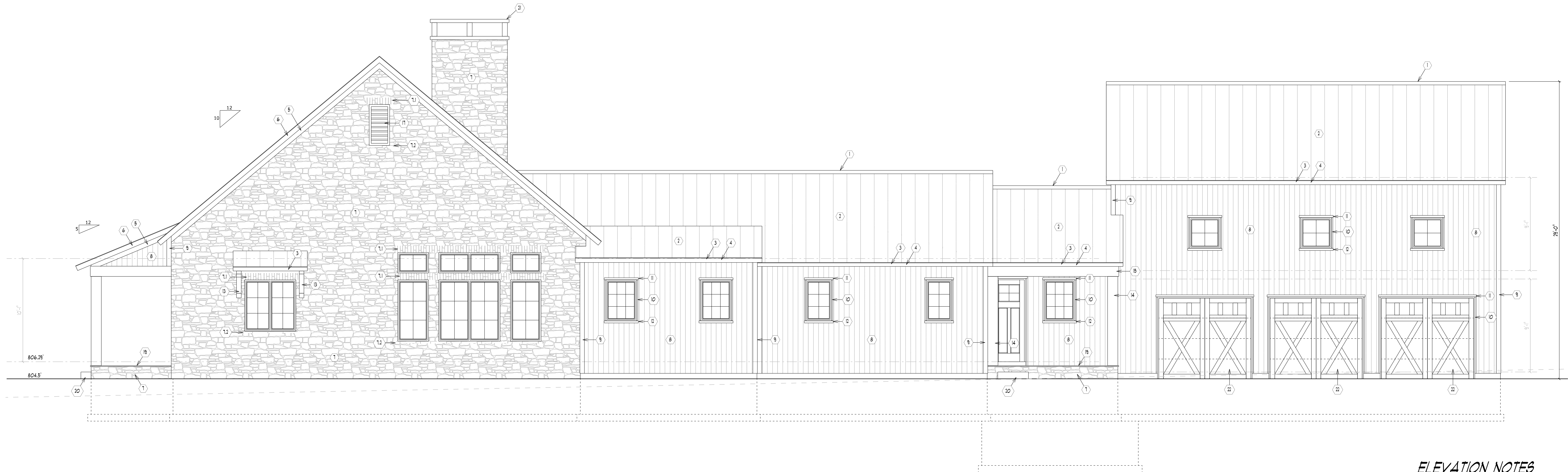

NORTH ELEVATION

SCALE: 1/4" = 1'-0"

ELEVATION NOTES

- ROOF/TRIM**
- 1 VENTED RIDGE CAP
- 2 PREFINISHED STANDING SEAM METAL ROOF 16" PANEL WIDTH
- 21 SLATE SHINGLES
- 2.2 SINGLE-PLY RUBBER MEMBRANE ROOFING
- 3 1X6 FASCIA - FIELD PAINTED
- 4 6" HALF-ROUND GALVANIZED STEEL CUTTER AND 4" ROUND GALVANIZED STEEL DOWNSPOUTS
- 5 1X6 FRIEZE - FIELD PAINTED
- 6 1X6 BAKE - FIELD PAINTED
- WALLS/TRIM**
- 7 CULTURED STONE VENEER WITH BUTTERED JOINTS
- 7.1 CULTURED STONE HEAD - SEE DETAIL SHEET A00
- 7.2 CULTURED STONE SILL - SEE DETAIL SHEET A00
- 8 1X6 TONGUE AND GROOVE VERTICAL SIDING - FIELD PAINTED/STAINED
- 9 1X4 CORNER TRIM - FIELD PAINTED
- 10 1X2 TRIM - FIELD PAINTED
- 11 HEAD TRIM (SEE DETAIL) - FIELD PAINTED
- 12 2X SILL - FIELD PAINTED
- 13 CUSTOM WOOD BRACKET - FIELD PAINTED - SEE DETAIL SHEET A00
- 14 BUILT-UP WOOD COLUMN - SEE DETAIL SHEET A00
- 15 BUILT-UP WOOD BEAM - SEE DETAIL SHEET A00
- 16 SCREENED PANEL
- 17 24" X 48" CUSTOM WOOD GABLE VENT WITH SCREENING - FIELD PAINTED
- 18 1X WOOD TRIM - FIELD PAINTED
- MISC**
- 19 CUT LIMESTONE PORCH
- 20 CUT LIMESTONE SLAB STEP
- 21 STONE CHIMNEY CAP - SEE DETAIL SHEET A00
- 22 COMPOSITE OVERHEAD DOOR

Custom Home For
Paul and Kathie Ghidotti
185 S. Riverview St.
Dublin, Ohio 43017

RTA Project Number
CH0320

	Date
Preliminary	000000
Bidding	000000
Construction	000000

Revision	Date
	000000

This Drawing And This Design Are The Copyrighted Property Of Richard Taylor Architects And May Not Be Reproduced, Altered, Or Otherwise Used In Any Manner Without The Written Consent Of Richard Taylor Architects

This Drawing Is Not To Be Submitted For Permits Without The Architect's Seal Below



NORTH ELEVATION

SCALE: 1/4" = 1'-0"

ELEVATION NOTES

- ROOF/TRIM**
- 1 VENTED RIDGE CAP
- 2 PREFINISHED STANDING SEAM METAL ROOF 16" PANEL WIDTH
- 21 SLATE SHINGLES
- 22 SINGLE-PLY RUBBER MEMBRANE ROOFING
- 3 1 X 6 FASCIA - FIELD PAINTED
- 4 6" HALF-ROUND GALVANIZED STEEL CUTTER AND 4" ROUND GALVANIZED STEEL DOWNSPOUTS
- 5 1 X 6 FRIEZE - FIELD PAINTED
- 6 1 X 6 RAKE - FIELD PAINTED
- WALLS/TRIM**
- 7 CULTURED STONE VENEER WITH BUTTERED JOINTS
- 71 CULTURED STONE HEAD - SEE DETAIL SHEET A00
- 72 CULTURED STONE SILL - SEE DETAIL SHEET A00
- 8 1 X 6 TONGUE AND GROOVE VERTICAL SIDING FIELD PAINTED/STAINED
- 9 1 X 4 CORNER TRIM - FIELD PAINTED
- 10 1 X 2 TRIM - FIELD PAINTED
- 11 HEAD TRIM (SEE DETAIL) - FIELD PAINTED
- 12 2 X SILL - FIELD PAINTED
- 13 CUSTOM WOOD BRACKET - FIELD PAINTED (SEE DETAIL SHEET A00)
- 14 BUILT-UP WOOD COLUMN - SEE DETAIL SHEET A00
- 15 BUILT-UP WOOD BEAM - SEE DETAIL SHEET A00
- 16 SCREENED PANEL
- 17 2 1/2" X 4 1/2" CUSTOM WOOD CABLE VENT WITH SCREENING - FIELD PAINTED
- 18 1 X WOOD TRIM - FIELD PAINTED
- MISC**
- 19 CUT LIMESTONE PORCH
- 20 CUT LIMESTONE SLAB STEP
- 21 STONE CHIMNEY CAP - SEE DETAIL SHEET A00
- 22 COMPOSITE OVERHEAD DOOR

Custom Home For
Paul and Kathie Ghidotti
185 S. Riverview St.
Dublin, Ohio 43017

RTA Project Number
CH0320

	Date
Preliminary	000000
Bidding	000000
Construction	000000

Revision	Date
	000000

This Drawing And This Design Are The Copyrighted Property Of Richard Taylor Architects And May Not Be Reproduced, Altered, Or Otherwise Used In Any Manner Without The Written Consent Of Richard Taylor Architects.

This Drawing is Not To Be Submitted For Permits Without The Architect's Seal Below

	Date
Preliminary	000000
Bidding	000000
Construction	000000

Revision	Date
	000000

This Drawing And This Design Are The Copyrighted Property Of Richard Taylor Architects And May Not Be Reproduced, Altered, Or Otherwise Used In Any Manner Without The Written Consent Of Richard Taylor Architects

This Drawing Is Not To Be Submitted For Permits Without The Architect's Seal Below



SOUTH ELEVATION

SCALE: 1/4" = 1'-0"

ELEVATION NOTES

- ROOF/TRIM**
- 1 VENTED RIDGE CAP
- 2 PREFINISHED STANDING SEAM METAL ROOF 16" PANEL WIDTH
- 21 SLATE SHINGLES
- 22 SINGLE-PLY RUBBER MEMBRANE ROOFING
- 3 1X6 FASCIA - FIELD PAINTED
- 4 6" HALF-ROUND GALVANIZED STEEL CUTTER AND 4" ROUND GALVANIZED STEEL DOWNSPOUTS
- 5 1X6 FRIEZE - FIELD PAINTED
- 6 1X6 RAKE - FIELD PAINTED
- WALLS/TRIM**
- 7 CULTURED STONE VENEER WITH BUTTERED JOINTS
- 71 CULTURED STONE HEAD - SEE DETAIL SHEET A00
- 72 CULTURED STONE SILL - SEE DETAIL SHEET A00
- 8 1X6 TONGUE AND GROOVE VERTICAL SIDING FIELD PAINTED/STAINED
- 9 1X4 CORNER TRIM - FIELD PAINTED
- 10 1X2 TRIM - FIELD PAINTED
- 11 HEAD TRIM (SEE DETAIL) - FIELD PAINTED
- 12 2X SILL - FIELD PAINTED
- 13 CUSTOM WOOD BRACKET - FIELD PAINTED SEE DETAIL SHEET A00
- 14 BUILT-UP WOOD COLUMN - SEE DETAIL SHEET A00
- 15 BUILT-UP WOOD BEAM - SEE DETAIL SHEET A00
- 16 SCREENED PANEL
- 17 24" X 48" CUSTOM WOOD CABLE VENT WITH SCREENING - FIELD PAINTED
- 18 1X WOOD TRIM - FIELD PAINTED
- MISC**
- 19 CUT LIMESTONE PORCH
- 20 CUT LIMESTONE SLAB STEP
- 21 STONE CHIMNEY CAP - SEE DETAIL SHEET A00
- 22 COMPOSITE OVERHEAD DOOR

Custom Home For
Paul and Kathie Ghidotti
185 S. Riverview St.
Dublin, Ohio 43017

RTA Project Number
CH0320

	Date
Preliminary	000000
Bidding	000000
Construction	000000

Revision	Date
	000000

This Drawing And This Design Are The Copyrighted Property Of Richard Taylor Architects And May Not Be Reproduced, Altered, Or Otherwise Used In Any Manner Without The Written Consent Of Richard Taylor Architects.

This Drawing Is Not To Be Submitted For Permits Without The Architect's Seal Below



SOUTH ELEVATION

SCALE: 1/4" = 1'-0"

ELEVATION NOTES

- ROOF/TRIM**
- 1 VENTED RIDGE CAP
- 2 PREFINISHED STANDING SEAM METAL ROOF 16" PANEL WIDTH
- 21 SLATE SHINGLES
- 22 SINGLE-PLY RUBBER MEMBRANE ROOFING
- 3 1 X 6 FASCIA - FIELD PAINTED
- 4 6" HALF-ROUND GALVANIZED STEEL CUTTER AND 4" ROUND GALVANIZED STEEL DOWNSPOUTS
- 5 1 X 6 FRIEZE - FIELD PAINTED
- 6 1 X 6 RAKE - FIELD PAINTED
- WALLS/TRIM**
- 7 CULTURED STONE VENEER WITH BUTTERED JOINTS
- 71 CULTURED STONE HEAD - SEE DETAIL SHEET A00
- 72 CULTURED STONE SILL - SEE DETAIL SHEET A00
- 8 1 X 6 TONGUE AND GROOVE VERTICAL SIDING FIELD PAINTED/STAINED
- 9 1 X 4 CORNER TRIM - FIELD PAINTED
- 10 1 X 2 TRIM - FIELD PAINTED
- 11 HEAD TRIM (SEE DETAIL) - FIELD PAINTED
- 12 2 X SILL - FIELD PAINTED
- 13 CUSTOM WOOD BRACKET - FIELD PAINTED (SEE DETAIL SHEET A00)
- 14 BUILT-UP WOOD COLUMN - SEE DETAIL SHEET A00
- 15 BUILT-UP WOOD BEAM - SEE DETAIL SHEET A00
- 16 SCREENED PANEL
- 17 2 1/2" X 4" CUSTOM WOOD CABLE VENT WITH SCREENING - FIELD PAINTED
- 18 1 X WOOD TRIM - FIELD PAINTED
- MISC**
- 19 CUT LIMESTONE PORCH
- 20 CUT LIMESTONE SLAB STEP
- 21 STONE CHIMNEY CAP - SEE DETAIL SHEET A00
- 22 COMPOSITE OVERHEAD DOOR



BUILDING SECTION E

SCALE: 1/4" = 1'-0"

RTA

RICHARD TAYLOR
ARCHITECTS

48 S. High St. Ste. B | Dublin, Ohio 43017
(614) 766-7257 | www.rtastudio.com

Custom Home For
**Paul and Kathie
Ghidotti**
185 S. Riverview St.
Dublin, Ohio 43017

RTA Project Number
CH0320

	Date
Preliminary	000000
Bidding	000000
Construction	000000

Revision	Date
	000000

This Drawing And This Design Are The Copyrighted Property Of Richard Taylor Architects And May Not Be Reproduced, Altered, Or Otherwise Used In Any Manner Without The Written Consent Of Richard Taylor Architects

This Drawing is Not To Be Submitted For Permits Without The Architect's Seal Below



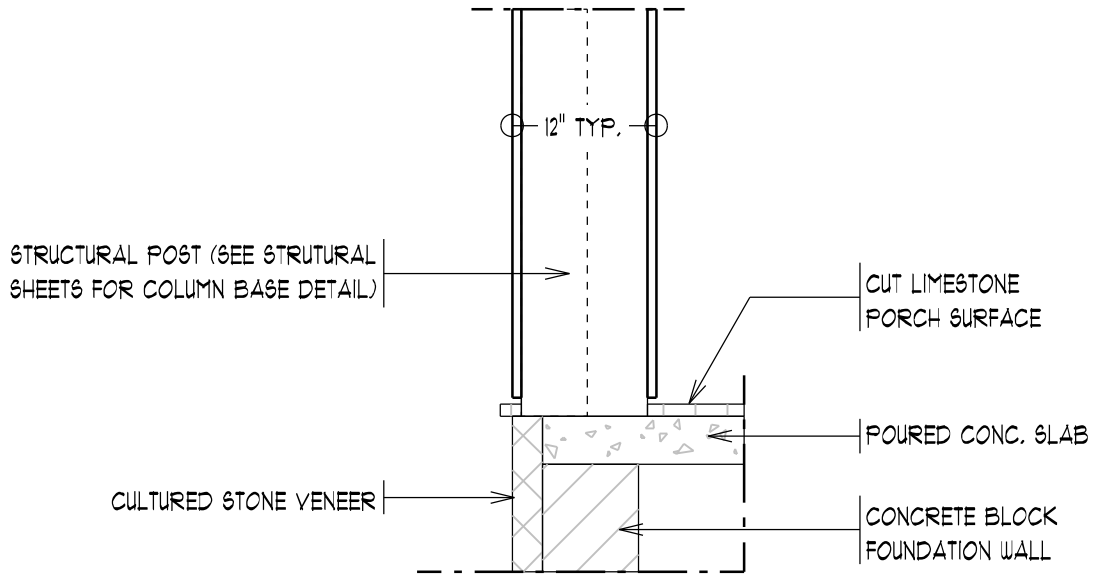
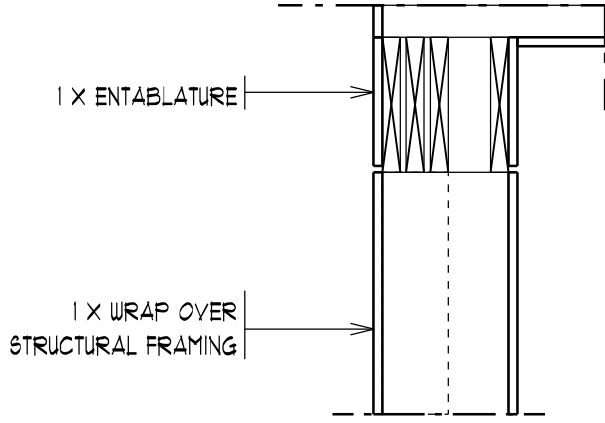

COLUMN DETAIL

SCALE: 3/4" = 1'- 0"

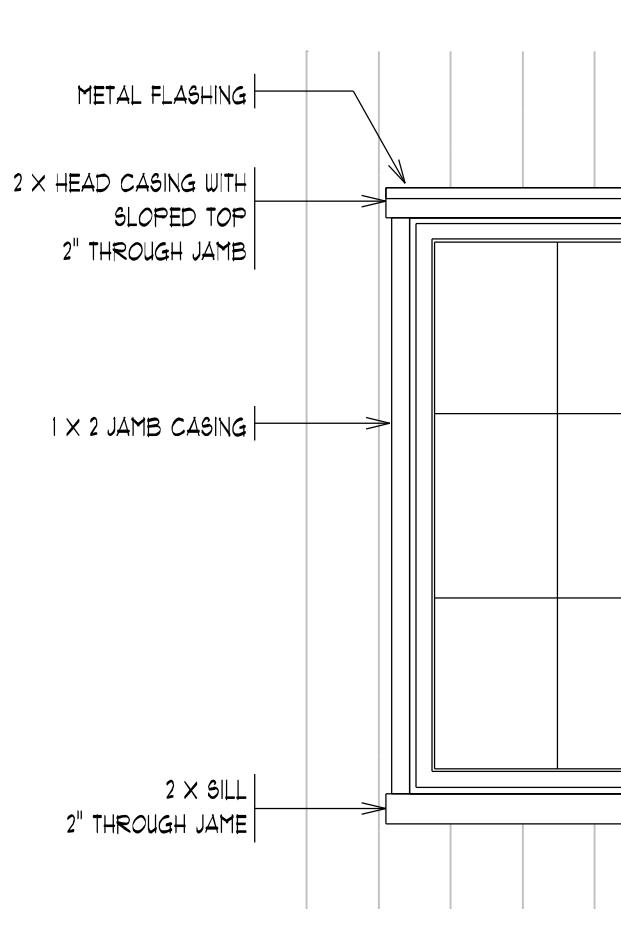

WINDOW TRIM DETAIL

SCALE: 3/4" = 1'-0"

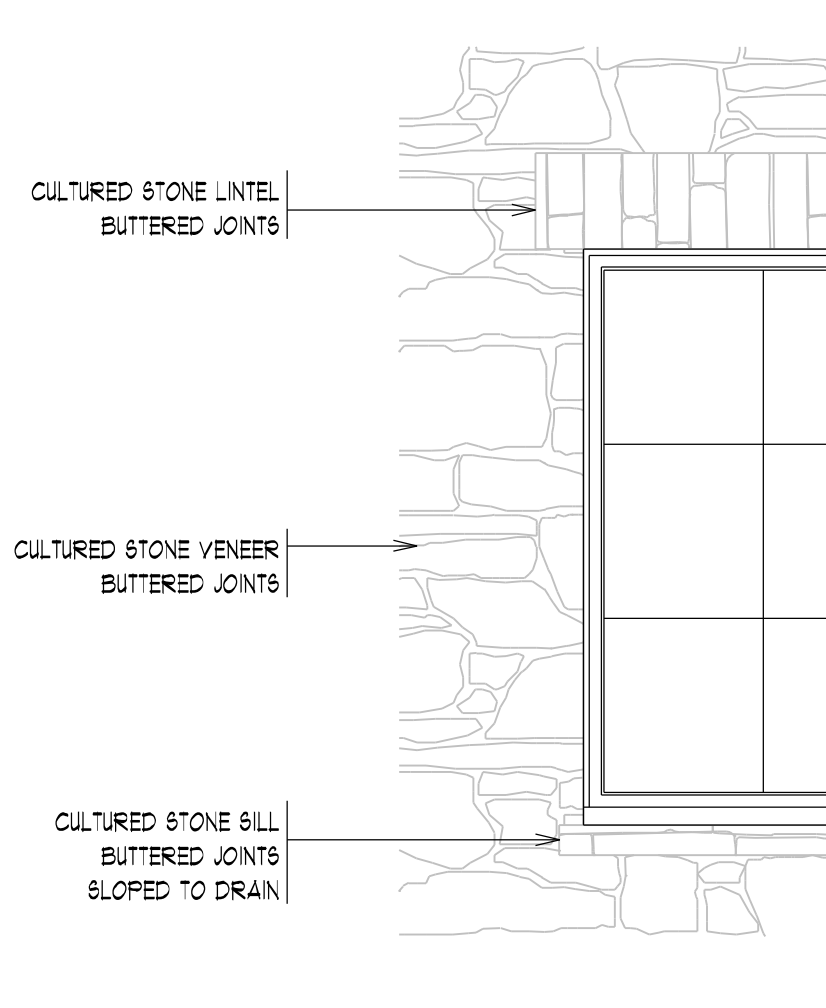

WINDOW DETAIL (STONE)

SCALE: 3/4" = 1'-0"