

CARRIAGE HOUSE 5-LAYER CONSTRUCTION

- 5-layer faux-wood doors with Intellicore® polyurethane insulation. 20.4 R-value.
- Multiple door designs and window options. Many custom designs also available. See your Clopay Dealer for more information.
- Insulated glass options include clear, frosted, seeded, rain and obscure. See page 20 for specialty glass options.
- Attractive beveled edge, clip-in window grilles are removable for easy cleaning.
- Replaceable vinyl bottom weatherseal in a rust-resistant aluminum retainer helps seal out the elements.
- 10-ball nylon rollers for quiet operation.
- Heavy-duty 14 gauge steel hinges for long-lasting performance.
- Clopay's Safe-T-Bracket® prevents serious injury that could occur if the bottom bracket were removed with the garage door closed and under tension.
- Comes complete with spade lift handles and step plates. See page 21 for details.



Design 01



Design 22



Design 34

Doors designs shown in Dark Finish with Clear Cypress cladding and Clear Cypress overlay. Design 01 does not have an overlay.

WINDOW/TOP SECTIONS



*Window grilles are Clear Cypress texture. Windows not available on Designs 31, 32, 33, 34, 35, 36, 37 and 38.
Standard windows available on the following widths only: 8'0", 10'0", 10'2", 12'0", 12'2", 13'6", 15'0", 15'2", 15'6", 15'8", 16'0", 16'2", 18'0", 18'2", 20'0", 20'2".
Impact windows available on the following widths only: 8'0", 9'0", 10'0", 12'2", 16'2", 18'2". To view additional designs, windows and top sections available, please visit www.clopaydoor.com.*

MATERIAL DESIGN OPTIONS

COMPOSITE CLADDING MATERIALS



Clear Cypress (C)

Mahogany (M)

Pecky Cypress (P)

COMPOSITE OVERLAY MATERIALS



Clear Cypress (C)

Mahogany (M)

Note: Cladding and overlay material options may be mixed and matched.



Design 11



Design 12



Design 13



Design 21



Design 23



Design 31



Design 32

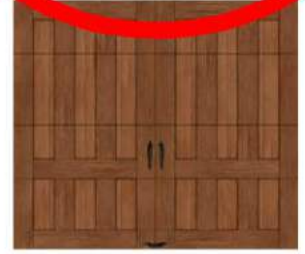

Design 33



Design 35



Design 36



Design 37



Design 38

COLORS



Medium Finish



Dark Finish



Walnut Finish



Slate Finish



Black Finish*



White Finish*



Primed (No Finish)

Black and White Finish available only on Mahogany cladding and overlays. Two-tone doors are available. To see all available options go to: www.clopaydoor.com/door-imagination-system.

Doors can be ordered primed for those homeowners wishing to custom paint or stain their doors. Door stain color will vary slightly within a door due to finishing process. Due to the printing process, above colors may vary. To request a color sample, visit www.clopaydoor.com/requestcolorsamples.

- 1 Composite Overlay
- 2 Composite Cladding
- 3 Steel
- 4 2" Intellicore® Polyurethane Insulation
- 5 Steel



2" POLYURETHANE INSULATION

EFFICIENCY
20.4
R-VALUE

COMPOSITE OVERLAY DELAMINATOR
LIMITED 5YR WARRANTY

HARDWARE
LIMITED 5YR WARRANTY

Calculated door section R-value is in accordance with DASMA TDS-163.



Installation Specifications

At www.CORONADO.com product specifications can be downloaded in CSI format.

Choices Specific to Euro Villa[®]

- Standard Colors:** Champagne, Timberlake or Any Custom Color
- Grout Joint Width:** Standard 1/2" Average Grout Joint, 1" Average Grout Joint or 1 1/2" Average Grout Joint
- Grouting Options:** Deep Raked, Full Brushed, Full Smooth Tooled, Overgrout or Rough Brushed
- Grout Joint Color:** Natural Grey, Natural Off-White or Complementary Color
- Accessories:** Corners, Complementary Tiles, Wall Caps, Post Caps and more. (See Accessories section of binder)

Special Installation Notes

- Pattern:** Blend the stone on the wall from several different boxes to ensure proper color and size variation.
- Grout Joints:** The 1" average grout joint consist primarily of 3/4" to 1" joints, not exceeding 1 1/2" joints. Keep joints tighter in areas where three or more stones intersect because the joint will appear larger after grouting. A full grout joint is recommended. When the edge of the stone is tapered, stones should be placed closer together or about 1/2" to 3/4" apart depending on the degree of taper. This will achieve a 1" joint at the surface of the stone. The deeper you rake the grout into the joint, the smaller the grout joint appears. The fuller the grout joint, the wider the joint appears.
- Sealing:** Not required. However, if installed on an exterior exposed to excessive water from runoff or improper drainage, we suggest the product be sealed in that particular area to protect it from staining or spalling during freeze-thaw cycles.
- Freeze-Thaw:** When installing stone in a freeze-thaw environment, extra care should be taken to ensure a full coverage of mortar on the back of each stone, which will prevent water pooling behind the stone after it's been installed.
- Installation Info:** Download Coronado's latest installation instructions at www.coronado.com for information on mortar and installation recommendations.

Profile Properties

- Size:** Stone sizes range from 4" to 12" in diameter, averaging 8" (nominal).
- Thickness:** 1" to 1 1/2"
- Weight:** 7 to 10 lbs. per square foot.
- Packaging:** Available in big boxes (100 sq ft Flats & 100 lft Corners) or Dura-Paks (12.5 sq ft Flats & 12.5 lft Corners).
When purchasing Euro Villa[®], coverage is based on installation with a 1/2" joint at the back of the stone.

3/4" Full Brushed Grout Joint



EURO VILLA[®]

COLOR: CHAMPAGNE

Overgrout Grout Joint



EURO VILLA[®]

COLOR: TIMBERLAKE

BELLAFORTÉ SLATE



LAKE VILLA, ILLINOIS



After hail destroyed the asphalt on this lakefront home, the roof was upgraded with Bellaforté tiles that can stand up to anything Mother Nature brings.

BELLAFORTÉ SLATE
EUROPEAN

*The look will amaze you.
The price might surprise you.*

Designed to reduce material costs, Bellaforté puts the look of slate within reach, and with it the premium aesthetics and performance that asphalt shingles can only dream about.

With DaVinci Bellaforté, the look of slate may be more attainable than you think.

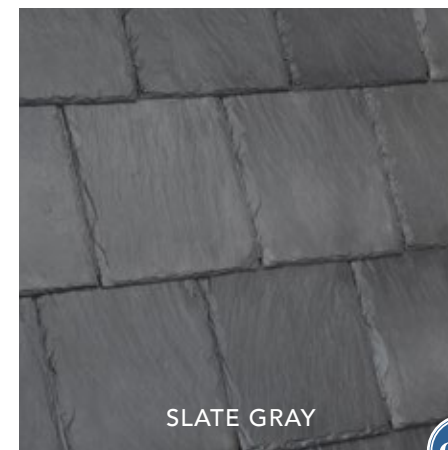
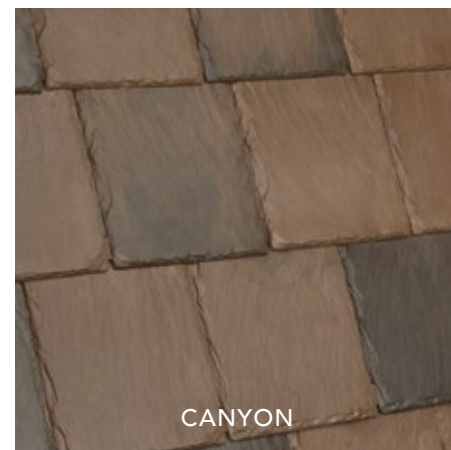
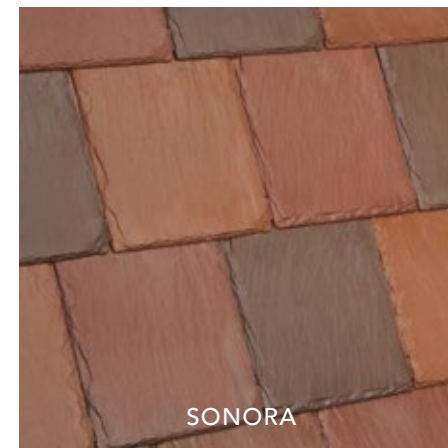
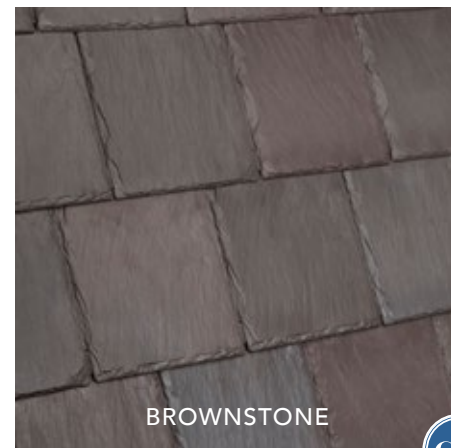

CR ALSO AVAILABLE
IN COOL ROOF COLOR

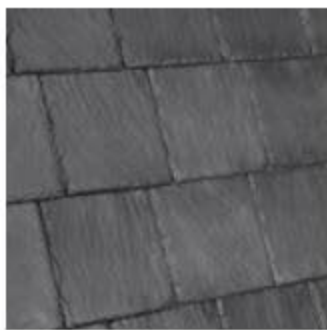
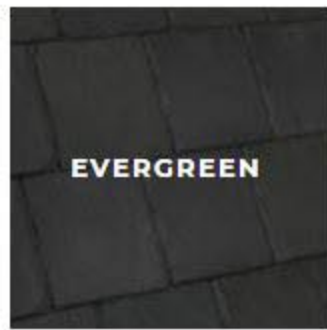
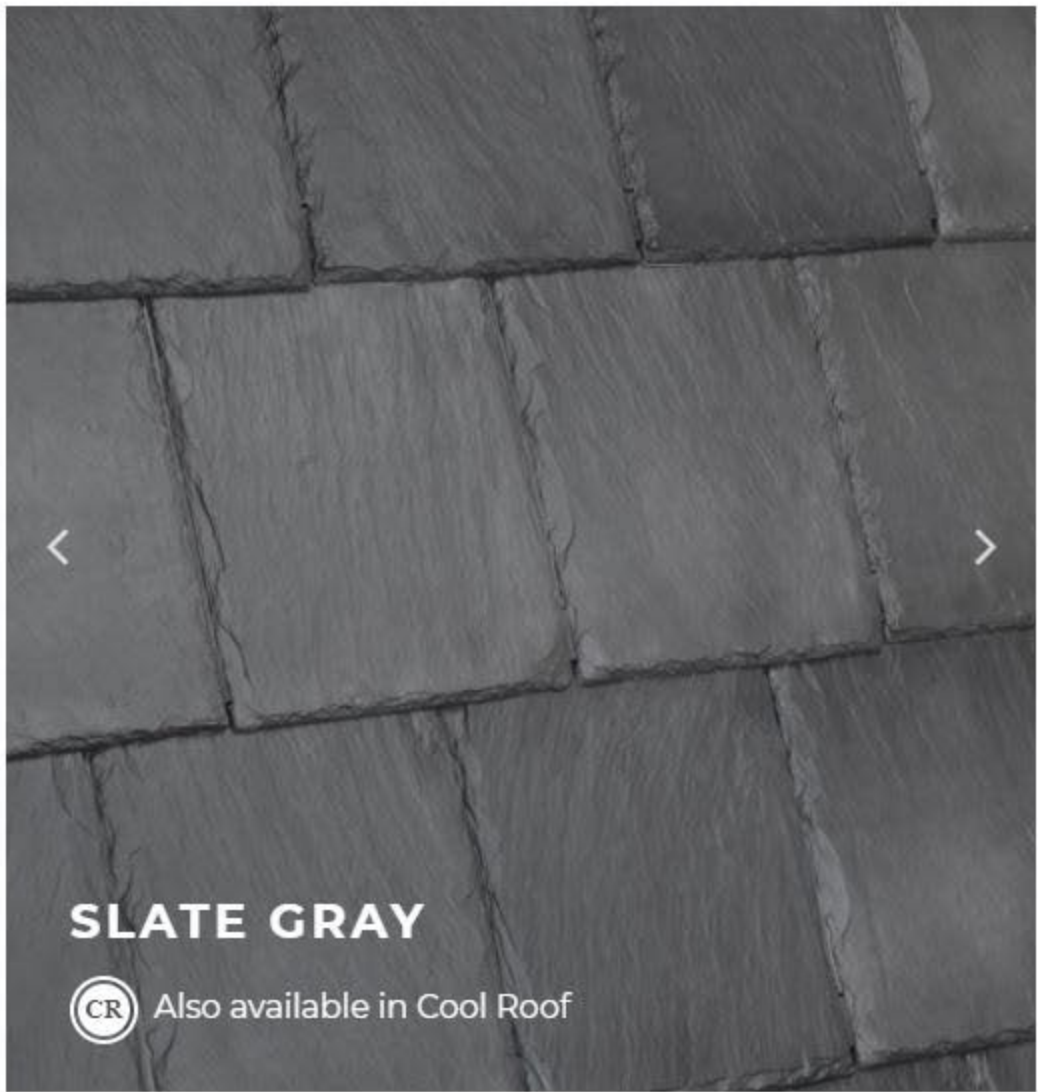

VENTED SOFFIT

ENGINEERED TO CUT OUT PROBLEMS

- The perfect alternative to MDO, plywood or hand-installed metal vents
- Precisely cut vents offer 10 square inches of ventilation per linear foot, making it easier to meet code requirements while adding architectural beauty
- Designed to minimize paint buildup and promote continuous airflow
- 1/8" vents to help keep hornets and bees out
- Eliminates time spent ripping full sheets
- Treated engineered wood strand substrate

38 SERIES VENTED CEDAR TEXTURE SOFFIT – CUT-TO-WIDTH

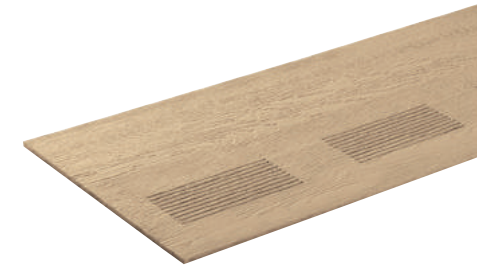
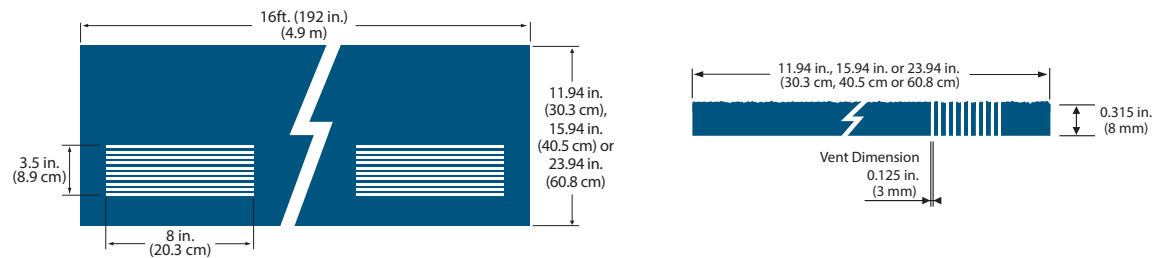

Cedar Texture

DESCRIPTION	LENGTH	ACTUAL WIDTH	MINIMUM THICKNESS	PID NUMBER	WEIGHT
38 Series Vented Cedar Texture Soffit – Cut-to-Width	16 ft. (192 in.)(4.9 m)	11.94 in. (30.3 cm)	0.315 in. (8 mm)	25822	-
	16 ft. (192 in.)(4.9 m)	15.94 in. (40.5 cm)	0.315 in. (8 mm)	25823	-
	16 ft. (192 in.)(4.9 m)	23.94 in. (60.8 cm)	0.315 in. (8 mm)	25824	-

NEW SMOOTH FINISH SOFFIT

THE PERFECT MATCH

- Installs quickly and easily
- Cut-to-width eliminates time spent ripping full sheets
- Pre-primed for exceptional paint adhesion
- Smooth finish
- Treated engineered wood strand substrate

38 SERIES SMOOTH FINISH SOFFIT - CUT-TO-WIDTH

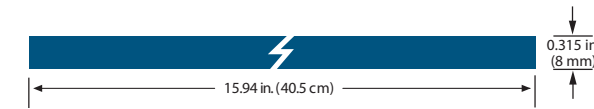

Smooth Finish

DESCRIPTION	LENGTH	ACTUAL WIDTH	MINIMUM THICKNESS	PID NUMBER	WEIGHT
38 Series Smooth Finish Soffit - Cut-to-Width	16 ft. (192 in.) (4.96 m)	15.94 in. (40.5 cm)	0.315 in. (8 mm)	42127	-

Features of the Ultimate Casement Window

- Available in heights up to 8.5 feet or widths up to 3.5 feet
- Industry-leading range of size options
- Multi-point locking system ensures a tight seal and security from top to bottom
- Unique wash mode allows access to both sides of glass from indoors
- Retractable screen option is nearly invisible when the screen is not in use
- Durable hardware for easy operation even at large sizes
- Hidden Lock Status Sensor option connects with your smart home to indicate when windows are closed and locked
- Available with IZ3 and IZ4 coastal/hurricane certification
- CE certified



INTERIOR

EXTERIOR

Exterior Finish

Clad Color Options



Bronze

A high-quality window deserves a dependable finish. Our low maintenance clad wood products feature an extruded aluminum exterior finished in commercial-grade paint for superior resistance to fading and chalking. Our palette of nineteen color options spans from muted, earthy tones to bold, rich colors and three pearlescent finishes. Custom color matching is also available to meet any design vision.

Selected Bronze



**Custom Colors: Any color. Any window or door. You name it. No matter what your inspiration for a custom window or door color, Marvin will match it. You get any color your heart desires, with your own personal custom color name and a 20-year warranty. See your Marvin dealer for details and ask about special pricing.*

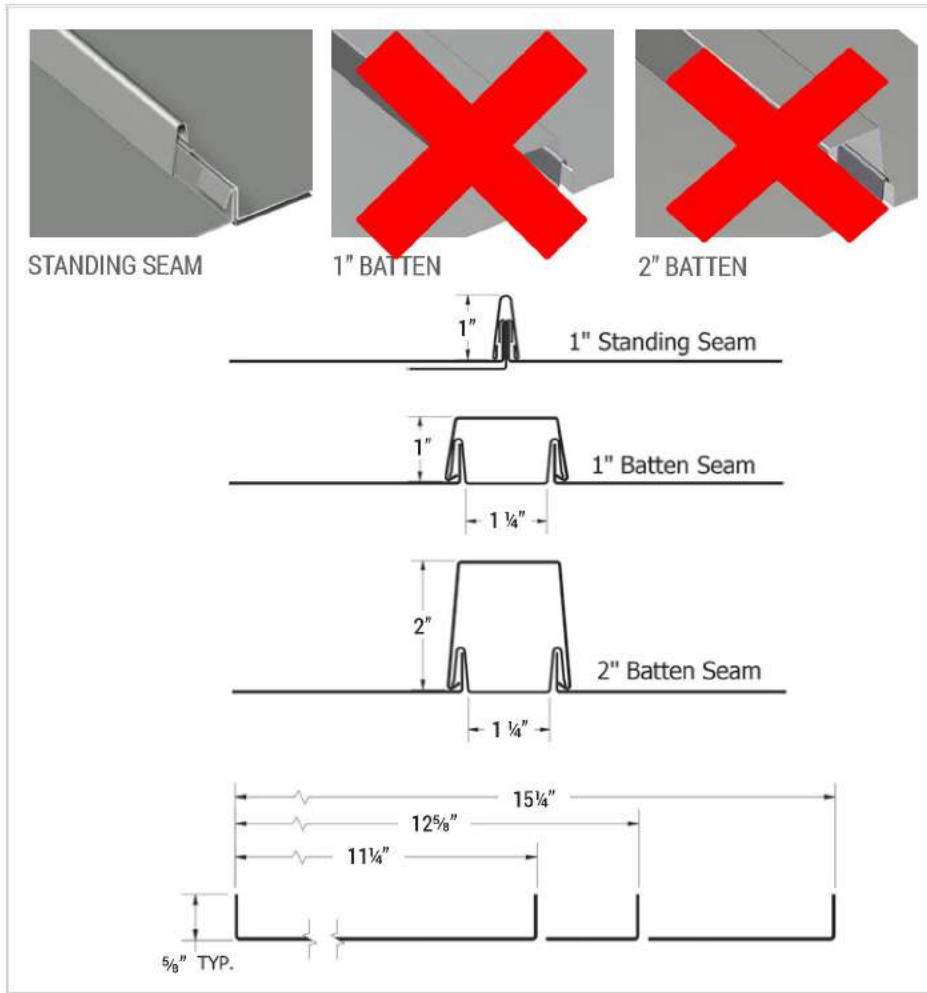

SKU:

Panel: PCP110, PCP120, PCP150, PCP999

Seam: PCS114

Batten: PCB001, PCB002

Copper: PCP147

Material:

.032, .040 aluminum;
22*, 24 ga. metallic coated steel;
16 oz. copper* (PCP147 only)

Panel Coverage:

11 1/4", 12 5/8", 14 5/8" †, 15 1/4"

Custom widths available

*Copper and Dark Bronze Anodized only

Minimum Panel Length:

2'-0" for straight, 3'-0" for curved

Seam Height:

Standing Seam: 1"

Batten Seam: 1" x 1 1/2" or 2" x 1 1/2"

Available:

Straight, Tapered, Curved† (Concave, Convex)

†Available in standing seam only

Texture:

Smooth or Embossed

Minimum Slope:

3:12

*Subject to minimum quantities and longer lead time. Inquire for availability.

Application:

- Two-part system that consists of the flat panel, and a separate seam or batten
- Seam is snapped over the clips, concealing the fastening system
- PC™ System panels are not structural and must be applied to a solid substrate
- Precision leveling prior to forming
- Fasteners and clips allow panels to float without causing stress
- Crating for job site handling/staging

Performance Standards:

- Tested in accordance with UL 790/ASTM E 108, UL 580, ASTM E 283, ASTM E 331, UL 2218, ASTM E 84 Flame Spread
- High reflectivity of panels which increases energy efficiency



Mix and match colors of the flat panel and standing seam or batten seam for a unique aesthetic.



PC System in Custom Yellow and Regal Blue



SMOOTH













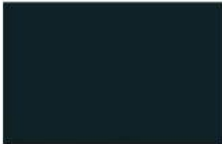





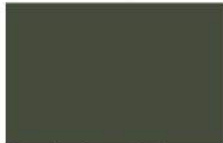









EMBOSSED







For more information: Visit www.atas.com/pc

COLOR CHART







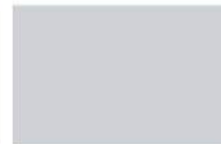

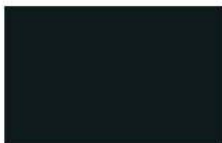

Stock Colors | 70% PVDF Finish

						
Black (02)	Classic Bronze (01)	Medium Bronze (03)	Hartford Green (27)	Forest Green (11)	Teal (19)	
						
Hemlock Green (30)	Patina Green (12)	Chocolate Brown (04)	Boysenberry (25)	Redwood (07)	Mission Red (08)	
						
Sierra Tan (09)	Rawhide (15)	Concord Cream (05)	Almond (36)	Sandstone (06)	Regal Blue (18)	
						
Slate Blue (21)	Siam Blue (14)	Rocky Grey (16)	Charcoal Grey (62)	Slate Grey (20)	Dove Grey (13)	
		Oxide Series				
Ascot White (10)	Bone White (26)				Copper Brown (42)	Tarnished Red (47)

Premium Colors | 70% PVDF Finish

					
Antique Patina (24)	Brite Red (17)	Champagne (31)	Coppertone (23)	Silversmith (28)	Titanium (35)

Natural Metals

					
Clear Satin Anodized (70)	Dark Bronze Anodized (71)	Acrylic Coated Galvalume® (97)	Copper (49)*	Classic Stainless Steel (40)*	Terne Coated Stainless Steel (41)*
					
Grey Zinc (91)*	Dark Zinc (92)*	Brown Zinc (89)*	Blue Zinc (94)*	Red Zinc (95)*	Green Zinc (96)*

For additional color offerings, visit www.atas.com/colors. For current SRI values and agency listings refer to our Color and Reference Guide: www.atas.com/sri.

*Special material. Pricing and availability dependent upon project specifics. Color chips available upon request.

www.atas.com | ATAS International, Inc.
800.468.1441 | Allentown, PA | Mesa, AZ



*Subject to minimum quantities and extended lead time. Inquire for material and panel width availability. Dutch Seam® is a registered trademark of ATAS International, Inc. Colors are as close to the actual colors as modern printing allows. Exact color chips on request; this is a requirement for all premium colors. If you have requirements or preference for colors or finishes other than shown, contact ATAS. Color availability varies by material, gauge and profile. ATAS is not responsible for colors selected from color chart. ATAS reserves the right to modify, eliminate and/or change its products without prior notification. Contact ATAS for more information. Every project is different. To the full extent permissible by law, ATAS disclaims all warranties, express or implied, including, but not limited to, implied warranties of merchantability and fitness for a particular purpose. A qualified engineer, architect or contractor should review suitability of use. Please visit www.atas.com for the most up-to-date information.



Market Street

[More Information](#)

[Interested In Ordering](#)



Sizes and Basic Specifications

Model	Dimensions	Extension	Gas	Electric
MS16	16" x 9"	11 1/4"	Single Burner	Double Light
MS19	19" x 10"	12"	Single Burner	Double Light
MS21	21" x 12"	14"	Single Burner	Triple Light

Line Drawings

[Market Street 16](#)

[Market Street 19](#)

[Market Street 21](#)

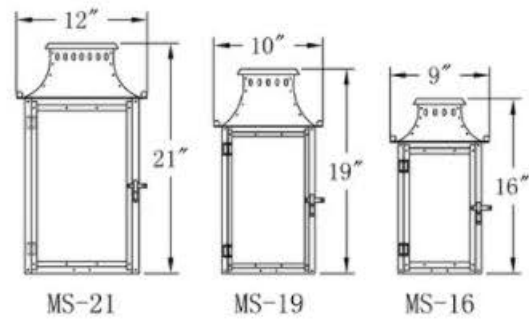

Finishes



Antique Copper



Black Satin



Graphite



Oil Rubbed Bronze

[Flame Information](#)